



A little about Fulgor Milano...

- 1949 Fulgor is founded as a coal-stove factory
- 1955 Fulgor first produces freestanding gas kitchen ranges
- 1974 Fulgor's built-in cooktops are created
- 1976 Fulgor's electric built-in ovens are first produced
- 1990 Creation of Fulgor's first built-in glass cooktop
- 1991 First European production of Fulgor's pyrolytic ovens
- 1994 First production of Fulgor's pyrolytic ovens for the North American market
- 2006 Meneghetti invents world's first dual-flame burner
- 2009 Fulgor celebrates 60 years; Fulgor Milano is born. A complete line of premium built-in appliances.
- 2019 Fulgor Milano celebrates 70 years

SINCE
PASSION | ITALIAN
1949



TABLE OF CONTENTS

	Page
About Fulgor Milano	2
Why Fulgor Milano?	6
Meet the 48" Sofia Range	8
Explore our Built-In Refrigerator	9
Crescendo Burner	10
Professional Collection	12
Sofia Ranges	13
Accento Ranges	21
Sofia Range Tops	26
Sofia Cooktops	32
Ventilation Hoods	37
Built-In Ovens	43
Specialty Ovens	46
Warming Drawer	48
Dishwashers	49
Refrigeration	50
Distinto Collection	55
700 Series Built-In Ovens	58
Steam & Speed Ovens	62
400 Series Built-In Ovens	64
100 Series Built-In Ovens	65
Warming Drawer	67
Coffee Machine	68
Microwave Ovens	69
Cooktops	72
Ventilation Hoods	80
Dishwashers	84
Fulgor Milano Warranty and Service Information	89
Maple Distributing, LLC Terms & Conditions of Sale	90

Fulgor Milano, an Italian brand by Meneghetti SPA, has been synonymous with excellence and innovation in the world of cooking since 1949. When Fulgor Milano became part of the Meneghetti family in 2009, the brand united its devotion to creativity with expert knowledge in the creation of premium built-in appliances.



A perfect balance of elegance, design, function and performance, this professional cooking line will satisfy the most discerning chef, while still providing a center piece for any kitchen design.

We invite you to explore Fulgor Milano premier kitchen appliances.



Why **FULGOR** MILANO?

» **SOFIA IS AN INDIVIDUAL (DESIGN)**

Fulgor Milano designed a professional range with a style and presence unique to her name. Sofia integrates the use of stainless steel and brushed aluminum for a design that is elegant and distinctive.

» **PROFESSIONALLY CRAFTED (FIT, FINISH, QUALITY)**

This multifunction range, combines all the features of a fully-equipped professional range with a stainless steel design which highlights the elegance and uniqueness of Italian style.

» **CRESCENDO BURNERS**

Because precision is important for powerful high and gentle low flames, our sealed burners offer five combinations of flame configurations for near infinite control. Durable brass burner rings provide exceptional heat distribution to the base of the cooking vessel at its maximum output of 20,000 BTUs and is also capable of the gentlest simmer aided by its oversized burner cap.

» **TOTAL CONTROL AND DELICATE POWER**

Every aspect of Sofia is beautiful and her gas cooking surface is no exception. Every burner allows you to temper the most delicate chocolate or sear a steak to perfection.

» **CAST IRON GRATES AND MATTE BURNER BASIN**

Heavy-duty cast-iron grates form a continuous surface for easy movement of pots and pans. You'll barely notice spillovers in this recessed burner basin and they'll clean up easily, too.

» **DUAL BURNER WITH BRASS BURNER**

For perfect control, easy cleaning, and lasting performance, the brass burner ring and the precision flame ports remain corrosion free.

» **ROBUST CONTROL KNOBS**

A perfect match for the bold design of the control panel, robust brushed metal knobs ensure easy handling and precise control while cooking.

» **AUTOGRAPH YOUR KITCHEN**

Customize your Sofia kitchen with a name of your choice. Visit the Fulgor Milano website to create your personalized name plate for the oven door. The complimentary plate will be delivered to your home where your unique Sofia kitchen is exclusively yours.

» **TOTAL ACCESS AT YOUR FINGERTIPS**

Choose multiple baking functions, timed baked, meat probe, and a variety of her customizable settings and baking features.



MEET THE 48" SOFIA RANGE

Thoughtfully designed surface cooking with six burner positions, each with a 5-in-1 Crescendo burner beneath continuous cast iron grates and a Trilaminar stainless steel griddle, providing unparalleled power and control to melt, simmer, sauté and sear as you desire. Below the cooking surface, two self cleaning convection ovens with intuitive multiple baking and broiling functions and the convenience of telescoping racks encourages you to cook the way you want.



EXPLORE OUR BUILT-IN REFRIGERATOR

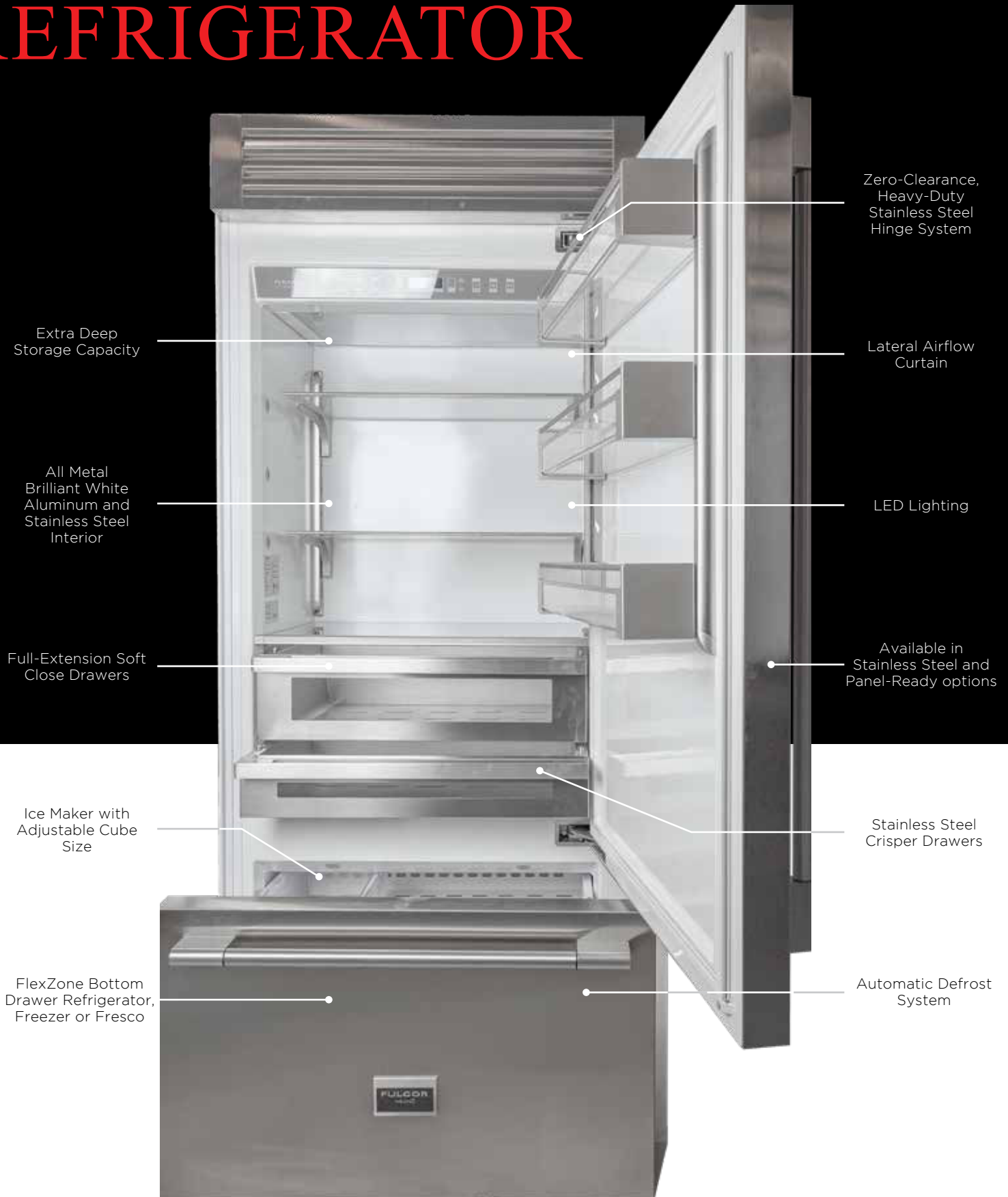

5 *in* 1

CRESCENDO BURNER

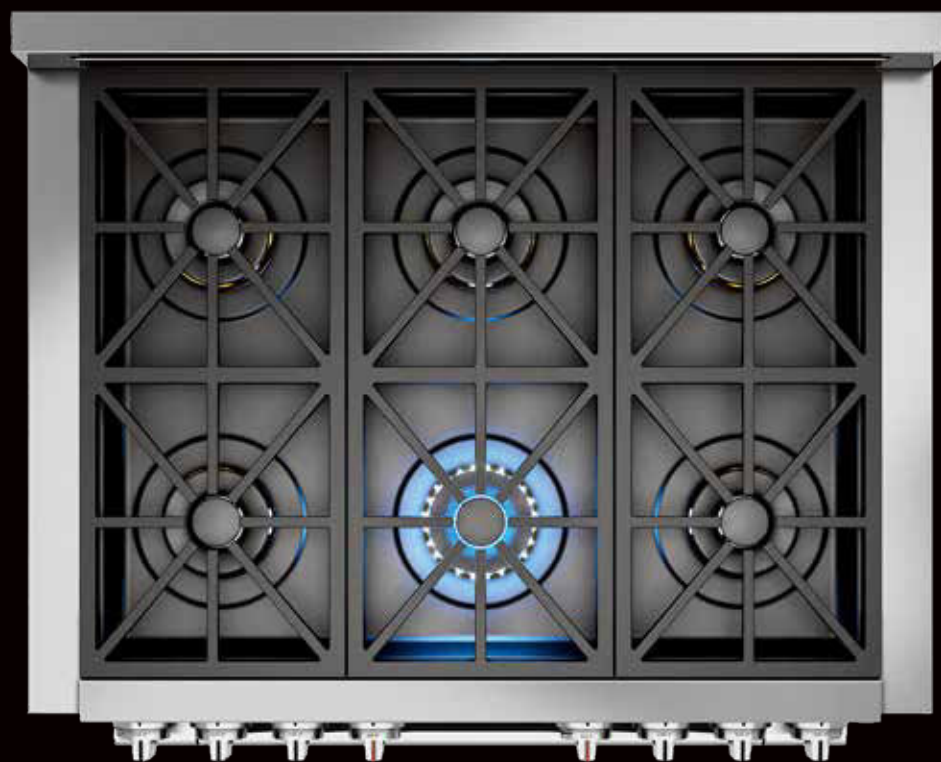

Because precision is important for powerful high and gentle low flames, our sealed burners offer five combinations of flame configurations for near infinite control. Durable brass burner rings provide exceptional heat distribution to the base of the cooking vessel at its maximum output of 20,000 BTU and is also capable of the gentlest simmer aided by its oversized burner cap.



FORTE

1

At the peak of its 20,000 BTU capability, meat is seared to produce a crust worthy of your favorite chef. Large pots quickly recover to a rigorous boil, and no culinary conquest seems unattainable. All burner rings engage to produce the most powerful flame for cooking.



MEZZOFORTE

2

Perfect al dente pasta is a snap. Progressive control of the burner ensures maximum heat distribution without excessive flame for an even and moderate boil.



MEZZO

3

Creamy risotto and smooth custards come to life as the burner rings combine to provide enough heat to encourage the cooking but discourage scorching.



PIANOFORTE

4

Simmer, poach, or braise your way to a tender sauce, soup or stew. Flame curls around the diffuser cap to barely brush the base of the cooking vessel with perfect control for extended periods of low heat cooking.



PIANO

5

Melt butter, temper chocolate, or gently coax the flavor from savory vegetables, this lowest setting is achieved by the flame from the simmer burner rolling gently under the diffuser cap to radiate whisper soft heat.

FULGOR

MILANO



SOFIA FREESTANDING RANGES

Sofia is a solid, generously sized freestanding range with a clean and rigorous style. Designed, developed and engineered in Italy to exceed all expectations of quality, performance and style. Sofia will captivate the most discerning chef with nuanced features that are traditional yet innovative.

STOCK ITEMS ARE HILIGHTED

SOFIA FREESTANDING RANGES - ALL GAS

F6PGR304S2

30" All Gas Professional Range
Series: 600
AVAILABLE IN 7 FINISHES



SOFIA
Professional Freestanding 600

SOFIA RANGES

Cooking Surface

- 2 Heavy Duty, Continuous Cast Iron Grates
- One Piece Matte Finish Porcelain Burner Bowl
- 4 Dual-Flame Crescendo Burners
- 1 Burner Provides Maximum 20,000 BTUs of Power
- 3 Burners Provide Maximum 18,000 BTUs of Power
- Standard Natural Gas, LP Conversion Kit Included
- Simmer Setting is 375 BTUs
- Cast Iron Island Trim

Oven

- Dual Convection
- Nova Broiler System
- Black Porcelain Enamel Interior
- Cool to Touch, Soft Closing Door
- Extra Large Baking Cavity
- 3 Halogen Lights for Flawless Visibility
- Glow Plug Ignition
- 4.4 cu. ft. Capacity
- 2 Chrome Racks
- 1 Telescopic Rack
- Enameled Broiler Pan
- Complimentary Personalized Nameplate
- Oven Temperature Electronic Control



Product Information

MODEL	WIDTH	FINISH	DESCRIPTION	MAP	MSRP
F6PGR304S2*	30"	Stainless Steel	All Gas Professional Range	\$ 4,999	\$ 5,349

Optional Accessories

MODEL	DESCRIPTION	MAP	MSRP
PDRKIT30MG	Color Door Kit, Matte Slate Gray	\$ 929	\$ 999
PDRKIT30WH	Color Door Kit, Glossy White	\$ 929	\$ 999
PDRKIT36MW	Color Door Kit, Matte White	\$ 929	\$ 999
PDRKIT30RD	Color Door Kit, Glossy Red	\$ 929	\$ 999
PDRKIT30BK	Color Door Kit, Glossy Black	\$ 929	\$ 999
PDRKIT30MB	Color Door Kit, Matte Black	\$ 929	\$ 999
F6BG30STD	Back Guard, 30", 3" Standard Trim*	\$ 179	\$ 199
F6BG30BCI	Back Guard, 30", Cast Iron Island Trim*	\$ 119	\$ 129
F6BG30HBT	Back Guard, 30", 9" High Back Trim*	\$ 269	\$ 289
FMSIM	Simmer Plate	\$ 69	\$ 74
FMWOK	Wok Ring	\$ 55	\$ 59
FMGRID30	Griddle, 30"	\$ 189	\$ 199
FMTRP30	Telescopic Rack, 30" Range	\$ 199	\$ 209
FMHAK30	High Altitude Kit, 30" Range	\$ 39	\$ 49

SOFIA FREESTANDING RANGES - ALL GAS

F6PGR366S2

36" All Gas Professional Range
Series: 600
AVAILABLE IN 7 FINISHES



SOFIA
Professional 600
Freestanding



Cooking Surface

- 3 Heavy Duty, Continuous Cast Iron Grates
- One Piece Matte Finish Porcelain Burner Bowl
- 6 Dual-Flame Crescendo Burners
- 2 Burners Provide Maximum 20,000 BTUs of Power
- 4 Burners Provide Maximum 18,000 BTUs of Power
- Simmer Setting is 375 BTUs
- Standard Natural Gas, LP Conversion Kit Included
- Cast Iron Island Trim

Oven

- Dual Convection
- Nova Broiler System
- Black Porcelain Enamel Interior
- Cool to Touch, Soft Closing Door
- Extra Large Baking Cavity
- 3 Halogen Lights for Flawless Visibility
- Glow Plug Ignition
- 5.7 cu. ft. Capacity
- 2 Chrome Racks
- 1 Telescopic Rack
- Enameled Broiler Pan
- Complimentary Personalized Nameplate
- Oven Temperature Electronic Control



Product Information

MODEL	WIDTH	FINISH	DESCRIPTION	MAP	MSRP
F6PGR366S2*	36"	Stainless Steel	All Gas Professional Range	\$ 6,299	\$ 6,749

Optional Accessories

MODEL	DESCRIPTION	MAP	MSRP
PDRKIT36MG	Color Door Kit, Matte Slate Gray	\$ 1,049	\$ 1,129
PDRKIT36WH	Color Door Kit, Glossy White	\$ 1,049	\$ 1,129
PDRKIT36MW	Color Door Kit, Matte White	\$ 1,049	\$ 1,129
PDRKIT36RD	Color Door Kit, Glossy Red	\$ 1,049	\$ 1,129
PDRKIT36BK	Color Door Kit, Glossy Black	\$ 1,049	\$ 1,129
PDRKIT36MB	Color Door Kit, Matte Black	\$ 1,049	\$ 1,129
F6BG36STD	Back Guard, 36", 3" Stainless Steel Trim*	\$ 189	\$ 209
F6BG36BCI	Back Guard, 36", Standard Cast Iron Island Trim*	\$ 119	\$ 129
F6BG36HBT	Back Guard, 36", 9" High Back Trim*	\$ 279	\$ 299
FMSIM	Simmer Plate	\$ 69	\$ 74
FMWOK	Wok Ring	\$ 55	\$ 59
FMGRID36	Griddle, 36"	\$ 169	\$ 179
FMTRP36	Telescopic Rack, 36" Range	\$ 209	\$ 229
FMHAK36	High Altitude Kit, 36" Range	\$ 39	\$ 49

STOCK ITEMS ARE HILIGHTED

SOFIA FREESTANDING RANGES - ALL GAS

SOFIA Professional 600 Freestanding



F6PGR486GS2

48" All Gas Professional Range
Series: 600
AVAILABLE IN 7 FINISHES



Cooking Surface

- 3 Heavy Duty, Continuous Cast Iron Grates
- Trilaminar Stainless Steel Griddle with Tubular Gas Burner
- Griddle Performs at 11,500 BTUs on High and 2,000 BTUs on Low
- One Piece, Matte Finish Porcelain Burner Bowl
- 6 Dual-Flame Crescendo Burners
- 2 Burners Provide Maximum 20,000 BTUs of Power
- 4 Burners Provide Maximum 18,000 BTUs of Power
- Standard Natural Gas, LP Conversion Kit Included
- Cast Iron Island Trim

Oven

- Dual Convection in Main Oven
- Nova Broiler System
- Single Convection in Accessory Oven
- Black Porcelain Enamel Interior
- Cool to Touch, Soft-Closing Door
- Extra Large Baking Cavity
- Glow Plug Ignition
- 3 Halogen Lights on Main Oven
- 2 Halogen Lights on Accessory Oven
- 4.4 CuFt on Main Oven, 2.7 CuFt on Accessory Oven
- 2 Chrome Racks / 1 Telescopic Rack per oven
- Complimentary Personalized Nameplate

SOFIA RANGES

Product Information

MODEL	WIDTH	FINISH	DESCRIPTION	MAP	MSRP
F6PGR486GS2*	48"	Stainless Steel	All Gas Professional Range	\$ 9,899	\$ 10,609

Optional Accessories

MODEL	DESCRIPTION	MAP	MSRP
PDRKIT48MG	Color Two Door Kit, Matte Slate Gray	\$ 1,649	\$ 1,769
PDRKIT48WH	Color Two Door Kit, Glossy White	\$ 1,649	\$ 1,769
PDRKIT48MW	Color Two Door Kit, Matte White	\$ 1,649	\$ 1,769
PDRKIT48RD	Color Two Door Kit, Glossy Red	\$ 1,649	\$ 1,769
PDRKIT48BK	Color Two Door Kit, Glossy Black	\$ 1,649	\$ 1,769
PDRKIT48MB	Color Two Door Kit, Matte Black	\$ 1,649	\$ 1,769
F6BG48STD	Back Guard, 48", 3" Stainless Steel Trim*	\$ 209	\$ 229
F6BG48BCI	Back Guard, 48", Standard Cast Iron Island Trim*	\$ 199	\$ 209
F6BG48HBT	Back Guard, 48", 9" High Back Trim*	\$ 359	\$ 379
FMSIM	Simmer Plate	\$ 69	\$ 74
FMWOK	Wok Ring	\$ 55	\$ 59
FMTRP30	Telescopic Rack, 30" Main Oven	\$ 199	\$ 209
FMTRP18	Telescopic Rack, 18" Accessory Oven	\$ 179	\$ 199
FMHAK48	High Altitude Kit, 48" Range	\$ 54	\$ 59

SOFIA FREESTANDING RANGES - DUAL FUEL

SOFIA
Professional 600
Freestanding



F6PDF304S1

30" Dual Fuel Professional Range
Series: 600
AVAILABLE IN 7 FINISHES



Cooking Surface

- 2 Heavy Duty, Continuous Cast Iron Grates
- One Piece, Matte Finish Porcelain Burner Bowl
- 4 Dual-Flame Crescendo Burners
- 1 Burner Provides Maximum 20,000 BTUs of Power
- 3 Burners Provide Maximum 18,000 BTUs of Power
- Simmer Setting is 375 BTUs
- Standard Natural Gas, LP Conversion Kit Included
- Cast Iron Island Trim

Oven

- Dual True Convection
- Self-Cleaning Oven with Multifunctioning Baking
- Black Porcelain Enamel Interior
- Cool to Touch, Soft-Closing Door
- Extra Large Baking Cavity
- 3 Halogen Lights for Flawless Visibility
- 4.4 cu. ft. Capacity
- 2 Chrome Racks
- 1 Telescopic Rack
- Enameled Broiler Pan
- Meat Probe
- Complimentary Personalized Nameplate



Glossy White



Glossy Black



Slate Gray



Glossy Red



Matte Black



Matte White

Product Information

MODEL	WIDTH	FINISH	DESCRIPTION	MAP	MSRP
F6PDF304S1*	30"	Stainless Steel	Dual Fuel Professional Range	\$ 5,499	\$ 5,899

Optional Accessories

MODEL	DESCRIPTION	MAP	MSRP
PDRKIT30MG	Color Door Kit, Matte Slate Gray	\$ 929	\$ 999
PDRKIT30WH	Color Door Kit, Glossy White	\$ 929	\$ 999
PDRKIT30MW	Color Door Kit, Matte White	\$ 929	\$ 999
PDRKIT30RD	Color Door Kit, Glossy Red	\$ 929	\$ 999
PDRKIT30BK	Color Door Kit, Glossy Black	\$ 929	\$ 999
PDRKIT30MB	Color Door Kit, Matte Black	\$ 929	\$ 999
F6BG30STD	Back Guard, 30", 3" Stainless Steel Trim*	\$ 179	\$ 199
F6BG30BCI	Back Guard, 30", Standard Cast Iron Island Trim*	\$ 119	\$ 129
F6BG30HBT	Back Guard, 30", 9" High Back Trim*	\$ 269	\$ 289
FMSIM	Simmer Plate	\$ 69	\$ 74
FMWOK	Wok Ring	\$ 55	\$ 59
FMGRID30	Griddle, 30"	\$ 189	\$ 199
FMTRP30	Telescopic Rack, 30" Range	\$ 199	\$ 209
FMHAK30	High Altitude Kit, 30" Range	\$ 39	\$ 49

STOCK ITEMS ARE HILIGHTED

SOFIA FREESTANDING RANGES - DUAL FUEL

SOFIA
Professional Freestanding 600

SOFIA RANGES

F6PDF366S1

36" Dual Fuel Professional Range
Series: 600
AVAILABLE IN 7 FINISHES



Cooking Surface

- 3 Heavy Duty, Continuous Cast Iron Grates
- One Piece, Matte Finish Porcelain Burner Bowl
- 6 Dual-Flame Crescendo Burners
- 2 Burners Provide Maximum 20,000 BTUs of Power
- 4 Burners Provide Maximum 18,000 BTUs of Power
- Simmer Setting is 375 BTUs
- Standard Natural Gas, LP Conversion Kit Included
- Cast Iron Island Trim

Oven

- Dual True Convection
- Self Cleaning Oven with Multifunction Baking
- Black Porcelain Enamel Interior
- Cool to Touch, Soft-Closing Door
- Extra Large Baking Cavity
- 3 Halogen Lights for Flawless Visibility
- 5.7 cu. ft. Capacity
- 2 Chrome Racks
- 1 Telescopic Rack
- Enameled Broiler Pan
- Meat Probe
- Complimentary Personalized Nameplate



Product Information

MODEL	WIDTH	FINISH	DESCRIPTION	MAP	MSRP
F6PDF366S1*	36"	Stainless Steel	Dual Fuel Professional Range	\$ 6,799	\$ 7,289

Optional Accessories

MODEL	DESCRIPTION	MAP	MSRP
PDRKIT36MG	Color Door Kit, Matte Slate Gray	\$ 1,049	\$ 1,129
PDRKIT36WH	Color Door Kit, Glossy White	\$ 1,049	\$ 1,129
PDRKIT36MW	Color Door Kit, Matte White	\$ 1,049	\$ 1,129
PDRKIT36RD	Color Door Kit, Glossy Red	\$ 1,049	\$ 1,129
PDRKIT36BK	Color Door Kit, Glossy Black	\$ 1,049	\$ 1,129
PDRKIT36MB	Color Door Kit, Matte Black	\$ 1,049	\$ 1,129
F6BG36STD	Back Guard, 36", 3" Stainless Steel Trim*	\$ 189	\$ 209
F6BG36BCI	Back Guard, 36", Standard Cast Iron Trim*	\$ 119	\$ 129
F6BG36HBT	Back Guard, 36", 9" High Back Trim*	\$ 279	\$ 299
FMSIM	Simmer Plate	\$ 69	\$ 74
FMWOK	Wok Ring	\$ 55	\$ 59
FMGRID36	Griddle, 36"	\$ 169	\$ 179
FMTRP36	Telescopic Rack, 36" Range	\$ 209	\$ 229
FMHAK36	High Altitude Kit, 36" Range	\$ 39	\$ 49

SOFIA Professional 600 Freestanding 600



SOFIA FREESTANDING RANGES - DUAL FUEL

F6PDF486GS1

48" Dual Fuel Professional Range

Series: 600

AVAILABLE IN 7 FINISHES



Cooking Surface

- 3 Heavy Duty, Continuous Cast Iron Grates
- Trilaminar Stainless Steel Griddle with Tubular Gas Burner
- Griddle Performs at 11,500 BTUs on High and 2,000 BTUs on Low
- One Piece, Matte Finish Porcelain Burner Bowl
- 6 Dual-Flame Crescendo Burners
- 2 Burners Provide Maximum 20,000 BTUs of Power
- 4 Burners Provide Maximum 18,000 BTUs of Power
- Standard Natural Gas, LP Conversion Kit Included
- Cast Iron Island Trim

Oven

- Dual True Convection in Main Oven
- True Convection in Accessory Oven
- Self-Cleaning Ovens with Multifunction Baking
- Black Porcelain Enamel Interior
- Cool to Touch, Soft-Closing Door
- Extra Large Baking Cavity
- 3 Halogen Lights on Main Oven
- 1 Halogen Light on Accessory Oven
- 4.4 CuFt on Main Oven, 2.7 CuFt on Accessory Oven
- 2 Chrome Racks / 1 Telescopic Rack Per Oven
- Meat Probe (Main Oven)
- Complimentary Personalized Nameplate

Product Information

MODEL	WIDTH	FINISH	DESCRIPTION	MAP	MSRP
F6PDF486GS1*	48"	Stainless Steel	Dual Fuel Professional Range	\$ 10,199	\$ 10,929

Optional Accessories

MODEL	DESCRIPTION	MAP	MSRP
PDRKIT48MG	Color Two Door Kit, Matte Slate Gray	\$ 1,649	\$ 1,769
PDRKIT48WH	Color Two Door Kit, Glossy White	\$ 1,649	\$ 1,769
PDRKIT48MW	Color Two Door Kit, Matte White	\$ 1,649	\$ 1,769
PDRKIT48RD	Color Two Door Kit, Glossy Red	\$ 1,649	\$ 1,769
PDRKIT48BK	Color Two Door Kit, Glossy Black	\$ 1,649	\$ 1,769
PDRKIT48MB	Color Two Door Kit, Matte Black	\$ 1,649	\$ 1,769
F6BG48STD	Back Guard, 48", 3" Stainless Steel Trim*	\$ 209	\$ 229
F6BG48BCI	Back Guard, 48", Standard Cast Iron Island Trim*	\$ 199	\$ 209
F6BG48HBT	Back Guard, 48", 9" High Back Trim*	\$ 359	\$ 379
FMSIM	Simmer Plate	\$ 69	\$ 74
FMWOK	Wok Ring	\$ 55	\$ 59
FMTRP30	Telescopic Rack, 30" Main Oven	\$ 199	\$ 209
FMTRP18	Telescopic Rack, 18" Accessory Oven	\$ 179	\$ 199
FMHAK48	High Altitude Kit, 48" Range	\$ 54	\$ 59

STOCK ITEMS ARE HILIGHTED

SOFIA FREESTANDING RANGES - INDUCTION

F6PIR304S1

30" Induction Professional Range
Series: 600
AVAILABLE IN 7 FINISHES



SOFIA
Professional 600
Freestanding



SOFIA RANGES

Cooking Surface

- 4 Single Induction Cooking Zones
- Elegant Ceramic Glass Surface
- Premium Induction Technology for Unsurpassed Performance
- Booster Function for Each Cooking Zone
- Residual Heat and Power-On Indicators
- Melting and Simmering Functions
- Pot Detection
- Child Lock Function
- Knob Controlled
- Digital Display Timer
- Stainless Steel Island Trim

Oven

- Dual True Convection
- Self-Cleaning Oven with Multifunction Baking
- Black Porcelain Enamel Interior
- Cool to Touch, Soft-Closing Door
- Extra Large Baking Cavity
- 3 Halogen Lights for Flawless Visibility
- 4.4 cu. ft. Capacity
- 2 Chrome Racks
- 1 Telescopic Rack
- Enameled Broiler Pan
- Meat Probe
- Complimentary Personalized Nameplate



Glossy White Glossy Black Slate Gray Glossy Red Matte Black Matte White

Product Information

MODEL	WIDTH	FINISH	DESCRIPTION	MAP	MSRP
F6PIR304S1*	30"	Stainless Steel	Induction Professional Range	\$ 5,999	\$ 6,429

Optional Accessories

MODEL	DESCRIPTION	MAP	MSRP
PDRKIT30MG	Color Door Kit, Matte Slate Gray	\$ 929	\$ 999
PDRKIT30WH	Color Door Kit, Glossy White	\$ 929	\$ 999
PDRKIT30MW	Color Door Kit, Matte White	\$ 929	\$ 999
PDRKIT30RD	Color Door Kit, Glossy Red	\$ 929	\$ 999
PDRKIT30BK	Color Door Kit, Glossy Black	\$ 929	\$ 999
PDRKIT30MB	Color Door Kit, Matte Black	\$ 929	\$ 999
F6BG30STD	Back Guard, 30", 3" Standard Trim*	\$ 179	\$ 199
F6BG30HBT	Back Guard, 30", 9" High Back Trim*	\$ 269	\$ 289
INDUKIT4	Induction Plate Kit, 4 Piece	\$ 139	\$ 149
FMTRP30	Telescopic Rack, 30" Sofia Range	\$ 199	\$ 209

*Range includes a Stainless Steel island trim.

SOFIA FREESTANDING RANGES - INDUCTION

SOFIA Professional 600 Freestanding



F6PIR365S1

36" Induction Professional Range
Series: 600
AVAILABLE IN 7 FINISHES



Cooking Surface

- 4 Single Induction Cooking Zones
- 1 Dual Max Power 11" Cooking Zone
- Elegant Ceramic Glass Surface
- Premium Induction Technology for Unsurpassed Performance
- Booster Function for Each Cooking Zone
- Residual Heat and Power-On Indicators
- Melting and Simmering Functions
- Pot Detection
- Child Lock Function
- Knob Controlled
- Digital Display Timer
- Stainless Steel Island Trim

Oven

- Dual True Convection
- Self-Cleaning Oven with Multifunction Baking
- Black Porcelain Enamel Interior
- Cool to Touch, Soft-Closing Door
- Extra Large Baking Cavity
- 3 Halogen Lights for Flawless Visibility
- 5.7 cu. ft. Capacity
- 2 Chrome Racks
- 1 Telescopic Rack
- Enameled Broiler Pan
- Meat Probe
- Complimentary Personalized Nameplate



Glossy White Glossy Black Slate Gray Glossy Red Matte Black Matte White

Product Information

MODEL	WIDTH	FINISH	DESCRIPTION	MAP	MSRP
F6PIR365S1*	36"	Stainless Steel	Induction Professional Range	\$ 7,999	\$ 8,569

Optional Accessories

MODEL	DESCRIPTION	MAP	MSRP
PDRKIT36MG	Color Door Kit, Matte Slate Gray	\$ 1,049	\$ 1,129
PDRKIT36WH	Color Door Kit, Glossy White	\$ 1,049	\$ 1,129
PDRKIT36MW	Color Door Kit, Matte White	\$ 1,049	\$ 1,129
PDRKIT36RD	Color Door Kit, Glossy Red	\$ 1,049	\$ 1,129
PDRKIT36BK	Color Door Kit, Glossy Black	\$ 1,049	\$ 1,129
PDRKIT36MB	Color Door Kit, Matte Black	\$ 1,049	\$ 1,129
F6BG36STD	Back Guard, 36", 3" Standard Trim*	\$ 179	\$ 199
F6BG36HBT	Back Guard, 36", 9" High Back Trim*	\$ 279	\$ 299
INDUKIT4	Induction Plate Kit, 4 Piece	\$ 139	\$ 149
FMTRP36	Telescopic Rack, 36" Sofia Range	\$ 209	\$ 229

*Range includes a Stainless Steel island trim.



ACCENTO FREESTANDING RANGES

The Accento line of professional ranges was inspired by traditional professional ranges but also designed to offer exceptional performance and value in a standard size. While still offering great value, there are no compromises in the structure, quality and attention to detail.

ACCENTO Professional 400

Freestanding

NEW



ACCENTO FREESTANDING RANGES - ALL GAS

F4PGR304S2

30" All Gas Professional Range

Series: 400

AVAILABLE IN 4 FINISHES



Cooking Surface

- 2 Heavy Duty, Continuous Cast Iron Grates
- One Piece Matte Finish Porcelain Burner Bowl
- 2 Dual-Flame 18,000 BTUs Crescendo Burners
- 2 15,000 BTUs Rapid Burners
- Standard Natural Gas, LP Conversion Kit Included
- Simmer Setting Adjustable to 375 BTUs
- Cast Iron Island Trim

Oven

- Silent Glow Plug Oven Ignition
- Dual Convection
- Black Porcelain Enamel Interior
- Cool to Touch Door
- Extra Large Baking Cavity
- 3 Halogen Lights for Flawless Visibility
- 4.4 cu. ft. Capacity
- 2 Chrome Racks
- Enameled Broiler Pan



Matte White



Glossy Red



Matte Black

Product Information

MODEL	WIDTH	FINISH	DESCRIPTION	MAP	MSRP
F4PGR304S2^	30"	Stainless Steel	All Gas Professional Range	\$ 3,879	\$ 4,149

Optional Accessories

MODEL	DESCRIPTION	MAP	MSRP
ACDKIT30MW	30" Accento Color Door Kit, Matte White	\$ 799	\$ 859
ACDKIT30RD	30" Accento Color Door Kit, Glossy Red	\$ 799	\$ 859
ACDKIT30MB	30" Accento Color Door Kit, Matte Black	\$ 799	\$ 859
F6BG30STD	Back Guard, 30", 3" Stainless Steel Trim*	\$ 179	\$ 199
F6BG30BCI	Back Guard, 30", Standard Cast Iron Island Trim*	\$ 119	\$ 129
F6BG30HBT	Back Guard, 30", 9" High Back Trim*	\$ 269	\$ 289
FMSIM	Simmer Plate	\$ 69	\$ 74
FMWOK	Wok Ring	\$ 55	\$ 59
FMGRID30	Griddle, 30"	\$ 189	\$ 199
FMTRP30	Telescopic Rack, 30" Range	\$ 199	\$ 209
FMHAK30	High Altitude Kit, 30" Range	\$ 39	\$ 49

*Range includes a cast iron island trim.

STOCK ITEMS ARE HILIGHTED

ACCENTO FREESTANDING RANGES - ALL GAS

ACCENTO RANGES

ACCENTO Professional 400

Freestanding

NEW



F4PGR366S2

36" All Gas Professional Range

Series: 400

AVAILABLE IN 4 FINISHES



Cooking Surface

- 3 Heavy Duty, Continuous Cast Iron Grates
- One Piece Matte Finish Porcelain Burner Bowl
- 3 Dual-Flame 18,000 BTUs Crescendo Burners
- 3 15,000 BTUs Rapid Burners
- Standard Natural Gas, LP Conversion Kit Included
- Simmer Setting Adjustable to 375 BTUs
- Cast Iron Island Trim

Oven

- Silent Glow Plug Oven Ignition
- Dual Convection
- Black Porcelain Enamel Interior
- Cool to Touch Door
- Extra Large Baking Cavity
- 3 Halogen Lights for Flawless Visibility
- 5.7 cu. ft. Capacity
- 2 Chrome Racks
- Enameled Broiler Pan



Matte White

Glossy Red

Matte Black

Product Information

MODEL	WIDTH	FINISH	DESCRIPTION	MAP	MSRP
F4PGR366S2*	36"	Stainless Steel	All Gas Professional Range	\$ 4,699	\$ 5,039

Optional Accessories

MODEL	DESCRIPTION	MAP	MSRP
ACDKIT36MW	36" Accento Color Door Kit, Matte White	\$ 899	\$ 969
ACDKIT36RD	36" Accento Color Door Kit, Glossy Red	\$ 899	\$ 969
ACDKIT36MB	36" Accento Color Door Kit, Matte Black	\$ 899	\$ 969
F6BG36STD	Back Guard, 36", 3" Stainless Steel Trim*	\$ 189	\$ 209
F6BG36BCI	Back Guard, 36", Standard Cast Iron Island Trim*	\$ 119	\$ 129
F6BG36HBT	Back Guard, 36", 9" High Back Trim*	\$ 279	\$ 299
FMSIM	Simmer Plate	\$ 69	\$ 74
FMWOK	Wok Ring	\$ 55	\$ 59
FMGRID36	Griddle, 36"	\$ 169	\$ 179
FMTRP36	Telescopic Rack, 36" Range	\$ 209	\$ 229
FMHAK36	High Altitude Kit, 36" Range	\$ 39	\$ 49

*Range includes a cast iron island trim.

ACCENTO Professional 400

Freestanding

NEW



F4PDF304S1

30" Dual Fuel Professional Range

Series: 400

AVAILABLE IN 4 FINISHES



Cooking Surface

- 2 Heavy Duty, Continuous Cast Iron Grates
- One Piece Matte Finish Porcelain Burner Bowl
- 2 Dual-Flame 18,000 BTUs Crescendo Burners
- 2 15,000 BTUs Rapid Burners
- Standard Natural Gas, LP Conversion Kit Included
- Simmer Setting Adjustable to 375 BTUs
- Cast Iron Island Trim

Oven

- Dual True Convection
- Self Cleaning Oven with Multifunctioning Baking
- Black Porcelain Enamel Interior
- Cool to Touch Door
- Extra Large Baking Cavity
- 3 Halogen Lights for Flawless Visibility
- 4.4 cu. ft. Capacity
- 2 Chrome Racks
- Enameled Broiler Pan



Matte White



Glossy Red



Matte Black

Product Information

MODEL	WIDTH	FINISH	DESCRIPTION	MAP	MSRP
F4PDF304S1*	30"	Stainless Steel	Dual Fuel Professional Range	\$ 3,999	\$ 4,289

Optional Accessories

MODEL	DESCRIPTION	MAP	MSRP
ACDKIT30MW	30" Accento Color Door Kit, Matte White	\$ 799	\$ 859
ACDKIT30RD	30" Accento Color Door Kit, Glossy Red	\$ 799	\$ 859
ACDKIT30MB	30" Accento Color Door Kit, Matte Black	\$ 799	\$ 859
F6BG30STD	Back Guard, 30", 3" Stainless Steel Trim*	\$ 179	\$ 199
F6BG30BCI	Back Guard, 30", Standard Cast Iron Island Trim*	\$ 119	\$ 129
F6BG30HBT	Back Guard, 30", 9" High Back Trim*	\$ 269	\$ 289
FMSIM	Simmer Plate	\$ 69	\$ 74
FMWOK	Wok Ring	\$ 55	\$ 59
FMGRID30	Griddle, 30"	\$ 189	\$ 199
FMTRP30	Telescopic Rack, 30" Range	\$ 199	\$ 209
FMHAK30	High Altitude Kit, 30" Range	\$ 39	\$ 49

*Range includes a cast iron island trim.

STOCK ITEMS ARE HILIGHTED

ACCENTO FREESTANDING RANGES - DUAL FUEL

ACCENTO Professional 400 Freestanding



F4PDF366S1

36" Dual Fuel Professional Range

Series: 400

AVAILABLE IN 4 FINISHES



Cooking Surface

- 3 Heavy Duty, Continuous Cast Iron Grates
- One Piece Matte Finish Porcelain Burner Bowl
- 3 Dual-Flame 18,000 BTUs Crescendo Burners
- 3 15,000 BTUs Rapid Burners
- Standard Natural Gas, LP Conversion Kit Included
- Simmer Setting Adjustable to 375 BTUs
- Cast Iron Island Trim

Oven

- Dual True Convection
- Self Cleaning Oven with Multifunctioning Baking
- Black Porcelain Enamel Interior
- Cool to Touch Door
- Extra Large Baking Cavity
- 3 Halogen Lights for Flawless Visibility
- 5.7 cu. ft. Capacity
- 2 Chrome Racks
- Enameled Broiler Pan



Matte White

Glossy Red

Matte Black

Product Information

MODEL	WIDTH	FINISH	DESCRIPTION	MAP	MSRP
F4PDF366S1*	36"	Stainless Steel	Dual Fuel Professional Range	\$ 4,799	\$ 5,149

Optional Accessories

MODEL	DESCRIPTION	MAP	MSRP
ACDKIT36MW	36" Accento Color Door Kit, Matte White	\$ 899	\$ 969
ACDKIT36RD	36" Accento Color Door Kit, Glossy Red	\$ 899	\$ 969
ACDKIT36MB	36" Accento Color Door Kit, Matte Black	\$ 899	\$ 969
F6BG36STD	Back Guard, 36", 3" Stainless Steel Trim*	\$ 189	\$ 209
F6BG36BCI	Back Guard, 36", Standard Cast Iron Island Trim*	\$ 119	\$ 129
F6BG36HBT	Back Guard, 36", 9" High Back Trim*	\$ 279	\$ 299
FMSIM	Simmer Plate	\$ 69	\$ 74
FMWOK	Wok Ring	\$ 55	\$ 59
FMGRID36	Griddle, 36"	\$ 169	\$ 179
FMTRP36	Telescopic Rack, 36" Range	\$ 209	\$ 229
FMHAK36	High Altitude Kit, 36" Range	\$ 39	\$ 49

*Range includes a cast iron island trim.

ACCENTO RANGES



SOFIA RANGE TOPS

Handcrafted in Italy, the Sofia Range Tops embody elegance, design and performance while also allowing the homeowner to have flexibility and the ability to customize when outfitting their kitchen.

STOCK ITEMS ARE HILIGHTED

SOFIA RANGE TOPS - GAS

SOFIA
Professional Range Tops 600

F6GRT304S1
30" Gas Professional Range Top
Series: 600



SOFIA RANGE TOPS



Features

- 2 Heavy Duty, Continuous Cast Iron Grates
- One Piece, Matte Finish Porcelain Burner Bowl
- 4 Dual-Flame Crescendo Burners
- 1 Burner Provides Maximum 20,000 BTUs of Power
- 3 Burners Provide Maximum 18,000 BTUs of Power
- Standard Natural Gas, LP Conversion Kit Included
- Electronic Re-Ignition System
- Flame-out Sensor
- Top Mount Injector
- Cast Iron Island Trim

Product Information

MODEL	WIDTH	FINISH	DESCRIPTION	MAP	MSRP
F6GRT304S1*	30"	Stainless Steel	All Gas Professional Range Top	\$ 2,399	\$ 2,579

Optional Accessories

MODEL	DESCRIPTION	MAP	MSRP
F6BG30STD	Back Guard, 30", 3" Stainless Steel Trim*	\$ 179	\$ 199
F6BG30BCI	Back Guard, 30", Standard Cast Iron Island Trim*	\$ 119	\$ 129
F6BG30HBT	Back Guard, 30", 9" High Back Trim*	\$ 269	\$ 289
FMSIM	Simmer Plate	\$ 69	\$ 74
FMWOK	Wok Ring	\$ 55	\$ 59
FMGRID30	Griddle, 30"	\$ 189	\$ 199

SOFIA RANGE TOPS - GAS

SOFIA RANGE TOPS

SOFIA
Professional 600
Range Tops

F6GRT366S1

36" Gas Professional Range Top
Series: 600



Features

- 3 Heavy Duty, Continuous Cast Iron Grates
- One Piece Matte Finish Porcelain Burner Bowl
- 6 Dual-Flame Crescendo Burners
- 2 Burners Provide Maximum 20,000 BTUs of Power
- 4 Burners Provide Maximum 18,000 BTUs of Power
- Simmer Setting is 375 BTUs
- Standard Natural Gas, LP Conversion Kit Included
- Electronic Re-Ignition System
- Flame-Out Sensor
- Top Mount Injectors
- Cast Iron Island Trim

Product Information

MODEL	WIDTH	FINISH	DESCRIPTION	MAP	MSRP
F6GRT366S1*	36"	Stainless Steel	All Gas Professional Range Top	\$ 2,999	\$ 3,219

Optional Accessories

MODEL	DESCRIPTION	MAP	MSRP
F6BG36STD	Back Guard, 36", 3" Stainless Steel Trim*	\$ 189	\$ 209
F6BG36BCI	Back Guard, 36", Standard Cast Iron Trim*	\$ 119	\$ 129
F6BG36HBT	Back Guard, 36", 9" High Back Trim*	\$ 279	\$ 299
FMSIM	Simmer Plate	\$ 69	\$ 74
FMWOK	Wok Ring	\$ 55	\$ 59
FMGRID36	Griddle, 36"	\$ 169	\$ 179

STOCK ITEMS ARE HILIGHTED

SOFIA RANGE TOPS - GAS

SOFIA
Professional 600
Range Tops

F6GRT486GS1
48" Gas Professional Range Top
Series: 600



SOFIA
RANGE TOPS



Features

- 3 Heavy Duty, Continuous Cast Iron Grates
- Trilaminar Stainless Steel Griddle with Tubular Gas Burner
- Griddle Performs at 11,500 BTUs on High and 2,000 BTUs on Lows
- One Piece Matte Finish Porcelain Burner Bowl
- 6 Dual-Flame Crescendo Burners
- 2 Burners Provide Maximum 20,000 BTUs of Power
- 4 Burners Provide Maximum 18,000 BTUs of Power
- Simmer Setting Adjustable to 375 BTUs
- Standard Natural Gas, LP Conversion Kit Included
- Electronic Re-Ignition System
- Flame-Out Sensor
- Top Mount Injectors
- Cast Iron Island Trim

Product Information

MODEL	WIDTH	FINISH	DESCRIPTION	MAP	MSRP
F6GRT486GS1*	48"	Stainless Steel	All Gas Professional Range Top	\$ 4,599	\$ 4,929

Optional Accessories

MODEL	DESCRIPTION	MAP	MSRP
F6BG48STD	Back Guard, 48", 3" Stainless Steel Trim*	\$ 209	\$ 229
F6BG48BCI	Back Guard, 48", Standard Cast Iron Trim*	\$ 199	\$ 209
F6BG48HBT	Back Guard, 48", 9" High Back Trim*	\$ 359	\$ 379
FMSIM	Simmer Plate	\$ 69	\$ 74
FMWOK	Wok Ring	\$ 55	\$ 59

SOFIA RANGE TOPS - INDUCTION

SOFIA RANGE TOPS

SOFIA
Professional Range Tops 600

F6IRT304S1

30" Professional Induction Range Top
Series: 600



Features

- 4 Single Induction Cooking Zones
- Elegant Ceramic Glass Surface
- Premium Induction Technology for Unsurpassed Performance
- Boost Function for Each Cooking Zone
- Automatic Heat-Up Time
- Residual Heat and Power On Indicators
- Melting and Simmering Functions
- Pot Detection System
- Child Lock Function
- Digital Power Level Display
- Stainless Steel Island Trim
- Knob Controlled

Product Information

MODEL	WIDTH	FINISH	DESCRIPTION	MAP	MSRP
F6IRT304S1*	30"	Stainless Steel	Induction Professional Range Top	\$ 2,899	\$ 3,109

Optional Accessories

MODEL	DESCRIPTION	MAP	MSRP
F6BG30STD	Back Guard, 30", 3" Standard Trim*	\$ 179	\$ 199
F6BG30BCI	Back Guard, 30", Cast Iron Island Trim*	\$ 119	\$ 129
F6BG30HBT	Back Guard, 30", 9" High Back Trim*	\$ 269	\$ 289
INDUKIT4	Induction Plate Kit, 4 Piece	\$ 139	\$ 149

*Range Top includes a stainless steel island trim.

STOCK ITEMS ARE HIGHLIGHTED

SOFIA RANGE TOPS - INDUCTION

SOFIA
Professional
Range Tops **600**

F6IRT365S1
36" Professional Induction Range Top
Series: 600



SOFIA
RANGE TOPS



Features

- 4 Single Induction Cooking Zones
- 1 Dual Max Power with 11" Cooking Zone
- Elegant Ceramic Glass Surface
- Premium Induction Technology for Unsurpassed Performance
- Boost Function for Each Cooking Zone
- Automatic Heat-Up Time
- Residual Heat and Power On Indicators
- Melting and Simmering Functions
- Pot Detection System
- Child Lock Function
- Digital Power Level Display
- Stainless Steel Island Trim
- Knob Controlled

Product Information

MODEL	WIDTH	FINISH	DESCRIPTION	MAP	MSRP
F6IRT365S1*	36"	Stainless Steel	Induction Professional Range Top	\$ 3,899	\$ 4,179

Optional Accessories

MODEL	DESCRIPTION	MAP	MSRP
F6BG36STD	Back Guard, 36", 3" Standard Stainless Steel Trim*	\$ 189	\$ 209
F6BG36BCI	Back Guard, 36", Cast Iron Trim*	\$ 119	\$ 129
F6BG36HBT	Back Guard, 36", 9" High Back Trim*	\$ 279	\$ 299
INDUKIT4	Induction Plate Kit, 4 Piece	\$ 139	\$ 149

* Range includes a Stainless Steel island trim.

FULGOR

MILANO



SOFIA COOKTOPS

With sleek lines, a continuous surface grate over powerful brass burners, and LED illuminated controls, the Sofia cooktop combines elegant design, responsive performance, and thoughtful convenience. Sofia enters a new realm with this low profile cooktop allowing design flexibility for your kitchen.

SOFIA
Professional 400
Cooktops

F4PGK305S1
30" Gas Professional Cooktop
Series: 400



SOFIA
COOKTOPS



Features

- 3 Heavy Duty Continuous Cast Iron Grates
- Heavy Gauge 304 Stainless Steel Burner Bowl
- 1 Aluminum Dual Flame Burner with 20,000 BTUs
- 2 Aluminum Rapid Burners with 10,500 BTUs Each
- 2 Aluminum Semi-Rapid Burners with 8,000 BTUs Each
- Heavy Duty Control Panel
- Large Cooking Area
- Full Pot Stability
- Standard Natural Gas, LP Conversion Kit Included

Product Information

MODEL	WIDTH	FINISH	DESCRIPTION	MAP	MSRP
F4PGK305S1	30"	Stainless Steel	All Gas Professional Cooktop	\$ 1,299	\$ 1,399

Optional Accessories

MODEL	DESCRIPTION	MAP	MSRP
FMWOK	Wok Ring	\$ 55	\$ 59
FMSIM	Simmer Plate	\$ 69	\$ 74

SOFIA COOKTOPS - GAS

SOFIA COOKTOPS

SOFIA
Professional 400
Cooktops

F4PGK365S1

36" Gas Professional Cooktop

Series: 400

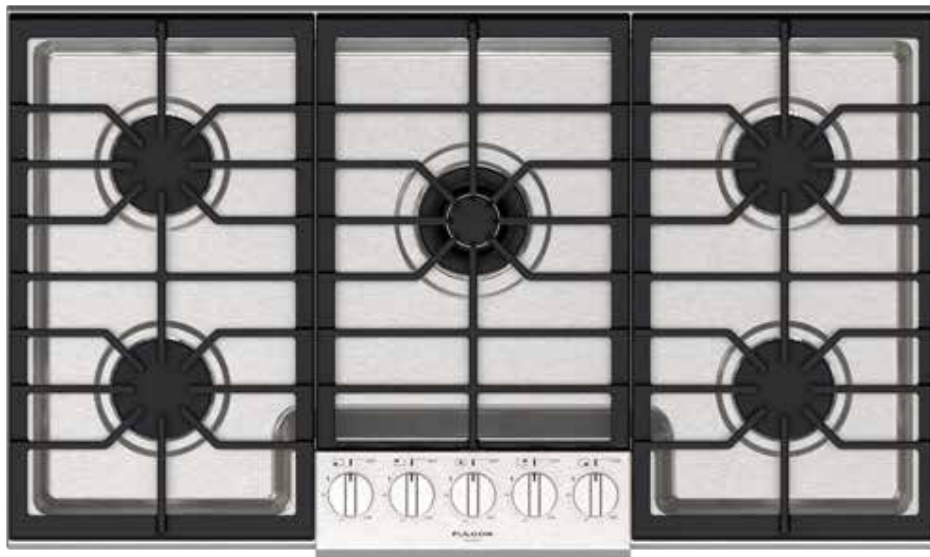

Features

- 3 Heavy Duty Continuous Cast Iron Grates
- Heavy Gauge 304 Stainless Steel Burner Bowl
- 1 Aluminum Dual Flame Burner with 20,000 BTUs
- 2 Aluminum Stacked Burners with 15,000 BTUs Each
- 1 Aluminum Stacked Burner with 12,000 BTUs
- 1 Aluminum Stacked Burner with 8,000 BTUs
- Heavy Duty Control Panel
- Large Cooking Area
- Full Pot Stability
- Standard Natural Gas, LP Conversion Kit Available

Product Information

MODEL	WIDTH	FINISH	DESCRIPTION	MAP	MSRP
F4PGK365S1	36"	Stainless Steel	All Gas Professional Cooktop	\$ 1,699	\$ 1,819

Optional Accessories

MODEL	DESCRIPTION	MAP	MSRP
FMWOK	Wok Ring	\$ 55	\$ 59
FMSIM	Simmer Plate	\$ 69	\$ 74

STOCK ITEMS ARE HILIGHTED

SOFIA COOKTOPS - GAS

SOFIA
Professional 600
Cooktops

F6PGK305S1

30" Gas Professional Cooktop
Series: 600



SOFIA
COOKTOPS

Featuring
Backlit
Control Knobs
and Brass
Burners

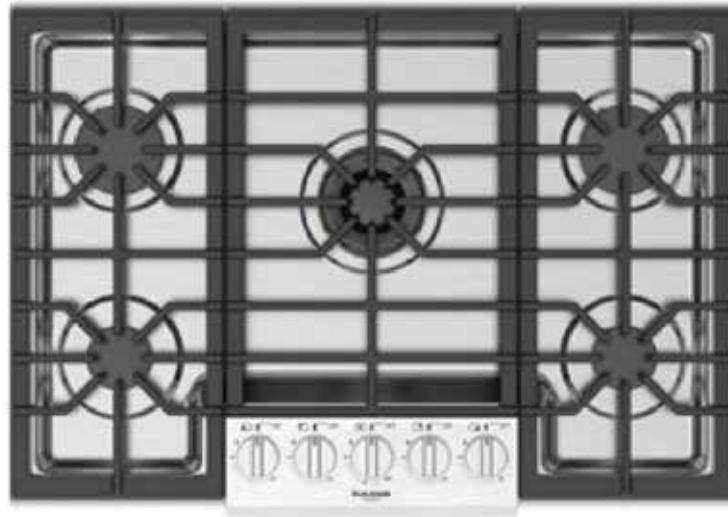

Features

- 3 Heavy Duty Continuous Cast Iron Grates
- Heavy Gauge 304 Stainless Steel Burner Bowl
- 1 Solid Brass Dual Flame Burner with 20,000 BTUs
- 2 Solid Brass Rapid Burners with 10,500 BTUs Each
- 2 Solid Brass Semi-Rapid Burners with 8,000 BTUs Each
- Backlit Control Knob Indicates Burner Operation (White)
- Backlit Control Knob Indicates Residual Heat (Red)
- Heavy Duty Control Panel
- Large Cooking Area
- Full Pot Stability
- Standard Natural Gas, LP Conversion Kit Included

Product Information

MODEL	WIDTH	FINISH	DESCRIPTION	MAP	MSRP
F6PGK305S1	30"	Stainless Steel	All Gas Professional Cooktop	\$ 1,599	\$ 1,709

Optional Accessories

MODEL	DESCRIPTION	MAP	MSRP
FMWOK	Wok Ring (center burner only)	\$ 55	\$ 59
FMSIM	Simmer Plate	\$ 69	\$ 74

SOFIA COOKTOPS - GAS

SOFIA
Professional Cooktops 600

F6PGK365S1
36" Gas Professional Cooktop
Series: 600



SOFIA COOKTOPS

Featuring
Backlit
Control Knobs
and Brass
Burners

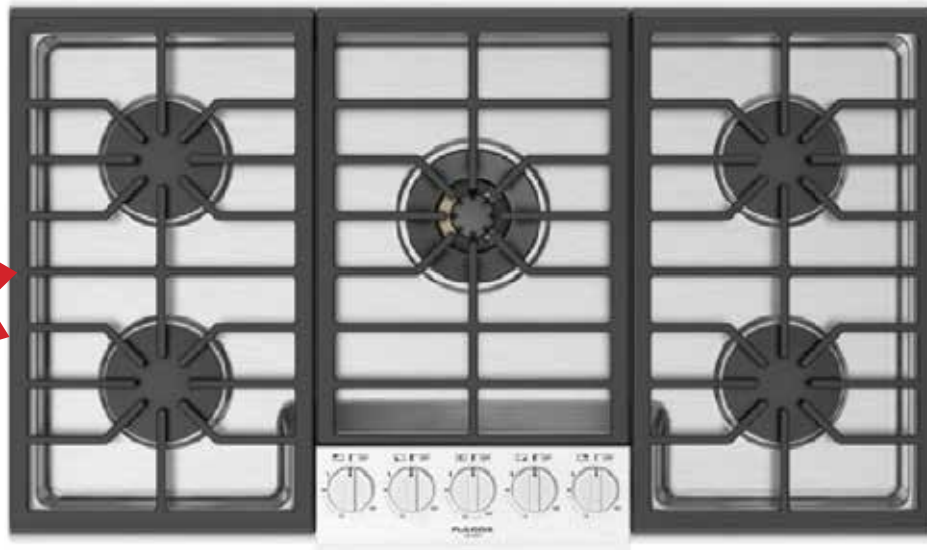

Features

- 3 Heavy Duty Continuous Cast Iron Grates
- Heavy Gauge 304 Stainless Steel Burner Bowl
- 1 Solid Brass Dual Flame Burner with 20,000 BTUs
- 4 Solid Brass Stacked Burners with 15,000 BTUs Each
- Backlit Control Knob Indicates Burner Operation (White)
- Backlit Control Knob Indicates Residual Heat (Red)
- Heavy Duty Control Panel
- Large Cooking Area
- Full Pot Stability
- Standard Natural Gas, LP Conversion Kit Available

Product Information

MODEL	WIDTH	FINISH	DESCRIPTION	MAP	MSRP
F6PGK365S1	36"	Stainless Steel	All Gas Professional Cooktop	\$ 1,899	\$ 2,039

Optional Accessories

MODEL	DESCRIPTION	MAP	MSRP
FMWOK	Wok Ring	\$ 55	\$ 59
FMSIM	Simmer Plate	\$ 69	\$ 74



SOFIA HOODS

The perfect complement to our Sofia Collection product, Fulgor Milano offers Professional hoods in two widths with smooth weld finished corner surface.

SOFIA HOODS

SOFIA
Professional Hoods **600**

F6PH30 Hood

30" Baffle Filter Professional Hood
Series: 600



Features

- Scotch Bright Stainless Steel
- Slider Controls
- LED Lighting
- 600 CFM
- Professional Baffle Filter
- One Fan Motor

Product Information

MODEL	WIDTH	FINISH	DESCRIPTION	MAP	MSRP
F6PH30S1	30"	Stainless Steel	Sofia Hood Baffle Filters	\$ 1,199	\$ 1,289
COMING FALL 2021 F6PH30S2	30"	Stainless Steel	Sofia Hood Baffle Filter	\$ 1,299	\$ 1,399

Optional Accessories

MODEL	DESCRIPTION	MAP	MSRP
F6CK30-12	30" Chimney Extension Cover, 12" Tall	\$ 229	\$ 249
FMFIL	Round Carbon Recirculating Filter	\$ 59	\$ 59

STOCK ITEMS ARE HILIGHTED

SOFIA HOODS

SOFIA
Professional Hoods 600

F6PH36 Hoods

36" Baffle Filter Professional Hood
Series: 600



Features

F6PH36S1

- Scotch Bright Stainless Steel
- Slider Controls
- LED Lighting
- 600 CFM
- Professional Baffle Filter
- One Fan Motor

F6PH36DS1

- Scotch Bright Stainless Steel
- Heavy Duty Control Panel with Knobs
- 4 Speed Control
- LED Lighting
- 1000 CFM
- Dual Fan Motors
- Professional Baffle Filter

Product Information

MODEL	WIDTH	FINISH	CFM	DESCRIPTION	MAP	MSRP
F6PH36S1	36"	Stainless Steel	600	Sofia Hood Baffle Filter	\$ 1,549	\$ 1,659
F6PH36DS1	36"	Stainless Steel	1000	Sofia Hood Baffle Filter	\$ 1,899	\$ 2,039

Optional Accessories

MODEL	DESCRIPTION	MAP	MSRP
F6CK36-12	36" Chimney Extension Cover, 12" Tall	\$ 249	\$ 269
FMFIL	Round Carbon Recirculating Filter	\$ 59	\$ 59

SOFIA
Professional Hoods 600

F6PH48DS1 Hood

48" Baffle Filter Professional Hood
Series: 600



Features

- Scotch Bright Stainless Steel
- Heavy Duty Control Panel with Knobs
- 4 Speed Control
- LED Lighting
- 1,000 CFM
- Dual Fan Motors
- Professional Baffle Filter

Product Information

MODEL	WIDTH	FINISH	CFM	DESCRIPTION	MAP	MSRP
F6PH48DS1	48"	Stainless Steel	1000	Sofia Hood Baffle Filter	\$ 2,149	\$ 2,299

Optional Accessories

MODEL	DESCRIPTION	MAP	MSRP
F6CK48-12	48" Chimney Extension Cover, 12" Tall	\$ 279	\$ 299
FMFIL	Round Carbon Recirculating Filter	\$ 59	\$ 59

STOCK ITEMS ARE HILIGHTED

SOFIA HOODS

SOFIA
Professional Hoods 600

F6PC36/F6PC48 Hood

36", 48" Baffle Filter Professional Chimney Hood
Series: 600



Features

- Scotch Brite Stainless Steel
- Heavy Duty Control Panel with Knobs
- 3 Speed Settings
- LED Lighting
- Dual Fan Motors
- Professional Baffle Filter
- 1,000 CFM
- Removable Logo
- Adjustable Duct Extension for up to 9' Ceiling

Product Information

MODEL	WIDTH	FINISH	CFM	DESCRIPTION	MAP	MSRP
F6PC36DS1	36"	Stainless Steel	1000	Sofia Hood Baffle Filter	\$ 1,999	\$ 2,149
F6PC48DS1	48"	Stainless Steel	1000	Sofia Hood Baffle Filter	\$ 2,249	\$ 2,409

Optional Accessories

MODEL	DESCRIPTION	MAP	MSRP
FMFIL	Round Carbon Recirculating Filter	\$ 59	\$ 59
KCPHN.00#3	Adjustable Chimney Extension (Max 60" / For 36" and 48" hoods)	\$ 246	\$ 265

SOFIA INSERT

SOFIA
Professional Insert **600**

F4BP28S1/ F6BP34DS1 / F6BP46DS1

28", 34", 46" Baffle Filter Professional Insert
Series: 600

SOFIA VENTILATION



Features

- Scotch Bright Stainless Steel
- Heavy Duty Control Panel with Knobs
- LED Lighting
- Mechanical Slider Control on 28' Model Only
- 600 CFM / 1000 CFM
- Dual Fan Motors on 1,000 CFM Models
- Professional Baffle Filter

Product Information

MODEL	WIDTH	FINISH	CFM	DESCRIPTION	MAP	MSRP
F4BP28S1	28"	Stainless Steel	600	Insert Baffle Filter	\$ 799	\$ 859
F6BP34S1	34"	Stainless Steel	600	Insert Baffle Filter	\$ 1,199	\$ 1,289
F6BP34DS1	34"	Stainless Steel	1000	Sofia Insert Baffle Filter	\$ 1,249	\$ 1,339
F6BP46DS1	46"	Stainless Steel	1000	Sofia Insert Baffle Filter	\$ 1,399	\$ 1,499

Optional Accessories

MODEL	DESCRIPTION	MAP	MSRP
FMFIL	Round Carbon Recirculating Filter	\$ 59	\$ 59

SOFIA BUILT-IN OVENS, WARMING DRAWER AND DISHWASHER

Fulgor Milano's Sofia Single and Double Built-In Wall Ovens offer the perfect harmony of beautiful aesthetics and premium performance to allow anyone to feel like a professional chef in the comfort of their home. To make life easier, Fulgor Milano offers three distinct styles of dishwashers maintaining the design integrity of your kitchen.



SOFIA Professional 600

Single Oven



SOFIA BUILT-IN OVENS - SINGLE

F6PSP30S1

30" Professional Single Oven

Series: 600

Available in 7 Finishes



Features

- Knob and Electronic Controls
- Dual True Convection
- Self-Cleaning Oven with Multi-function Baking
- Black Porcelain Enamel Interior
- Cool to Touch, Soft-Closing Door
- Extra-Large Baking Cavity and Viewing Area
- 3 Halogen Lights for Flawless Visibility
- Gross Capacity 4.4 cu. ft.
- 2 Chrome Racks
- 1 Telescopic Rack
- Enameled Broiler Pan
- Complimentary Personalized Nameplate
- Perfect for Installation Under a Cooktop

Oven Functions

- Bake
- Broil
- Roast
- Sabbath Mode
- Electronic Cooking Programmer
- True Convection
- Warm / Proof / Dehydrate / Defrost
- Timer Controlled Cooking
- Meat Probe
- Self Clean
- Bake
- Convection

Product Information

MODEL	WIDTH	FINISH	DESCRIPTION	MAP	MSRP
F6PSP30S1	30"	Stainless Steel	Professional Single Oven	\$ 3,349	\$ 3,589

Optional Accessories

MODEL	DESCRIPTION	MAP	MSRP
PDRKIT30MG	Color Door Kit, Matte Slate Gray	\$ 929	\$ 999
PDRKIT30WH	Color Door Kit, Glossy White	\$ 929	\$ 999
PDRKIT30MW	Color Door Kit, Matte White	\$ 929	\$ 999
PDRKIT30RD	Color Door Kit, Glossy Red	\$ 929	\$ 999
PDRKIT30BK	Color Door Kit, Glossy Black	\$ 929	\$ 999
PDRKIT30MB	Color Door Kit, Matte Black	\$ 929	\$ 999
FMTRP30	Telescopic Rack, 30"	\$ 199	\$ 209

Line drawing found on page 84

STOCK ITEMS ARE HILIGHTED

SOFIA BUILT-IN OVENS - DOUBLE

SOFIA
Professional 600
Double Oven



F6PDP30S1

30" Professional Double Oven
Series: 600
Available in 7 Finishes



SOFIA BUILT-INS

Features

- Knob and Electronic Controls
- Dual True Convection
- Self-Cleaning Oven with Multi-Function Baking
- Black Porcelain Enamel Interior
- Cool to Touch, Soft Closing Door
- Extra-Large Baking Cavity and Viewing Area
- 3 Halogen Lights for Flawless Visibility
- Gross Capacity 4.4 cu. ft. Per Oven
- 2 Chrome Racks Per Oven
- 1 Telescopic Rack Per Oven
- Enameled Broiler Pan
- Complimentary Personalized Nameplate (Bottom Oven Only)

Oven Functions

- Bake
- Broil
- Roast
- Convection
- True Convection
- Warm / Proof / Dehydrate / Defrost
- Timer Controlled Cooking
- Meat Probe (Top Oven)
- Self Clean
- Sabbath Mode
- Electronic Cooking Programmer

Product Information

MODEL	WIDTH	FINISH	DESCRIPTION	MAP	MSRP
F6PDP30S1	30"	Stainless Steel	Professional Double Oven	\$ 5,299	\$5,679

Optional Accessories

MODEL	DESCRIPTION	MAP	MSRP
F6PDPKIT30MG	Double Wall Oven Color Kit, 2 Doors, Matte Slate Gray	\$ 1,858	\$ 1,998
F6PDPKIT30WH	Double Wall Oven Color Kit, 2 Doors, Glossy White	\$ 1,858	\$ 1,998
F6PDPKIT30MW	Double Wall Oven Color Kit, 2 Doors, Matte White	\$ 1,858	\$ 1,998
F6PDPKIT30RD	Double Wall Oven Color Kit, 2 Doors, Glossy Red	\$ 1,858	\$ 1,998
F6PDPKIT30BK	Double Wall Oven Color Kit, 2 Doors, Glossy Black	\$ 1,858	\$ 1,998
F6PDPKIT30MB	Double Wall Oven Color Kit, 2 Doors, Matte Black	\$ 1,858	\$ 1,998
FMTRP30	Telescopic Rack, 30"	\$ 199	\$ 209

Line drawing found on page 85

SOFIA SPECIALTY OVENS - STEAM

SOFIA
Professional 600
Double Oven

F6PSCO30S1

30" Combi Convection Steam Oven

Series: 600

SOFIA BUILT-INS

NEW



Features

- 3-in-1 Combi Oven (Steam, Convection and Combi-Steam)
- 12 Cooking Functions
- Removable Water Tank
- Quick Access Menu
- 240 Volt Connection
- Pre-Loaded recipes that can be Customized
- Steam Recovery System
- Easy Steam Cleaning Cycle
- Limescale Water Filter
- Stainless Steel Interior
- Cool Touch Door
- Interior Lighting
- 1.2 CuFt Capacity

Included

- Meat Probe
- 1 Micro-perforated Pan with Stainless Steel Cover
- 1 Stainless Steel Tray
- 1 Flat Rack

Product Information

MODEL	WIDTH	FINISH	DESCRIPTION	MAP	MSRP
F6PSCO30S1	30"	Stainless Steel	Professional Steam Oven	\$ 2,799	\$2,999

SOFIA SPECIALTY OVENS - **SPEED**

SOFIA
Professional 600
Double Oven

F6PSPD30S1
30" Combi Convection Speed Oven
Series: 600

SOFIA
BUILT-INS



Features

- 3-in-1 Combi Oven (Microwave, Convection and Combination)
- 10 Cooking Functions
- Quick access menu
- Automatic programs
- Combined microwave and fan assisted mode
- 240 Volt Connection
- Microwave Mode has 6 Levels
- Pre-Loaded recipes that can be Customized
- Defrosting by Time and Weight
- Stainless Steel Interior
- Cool Touch Door
- Interior Lighting
- 1.2 CuFt Capacity

Product Information

MODEL	WIDTH	FINISH	DESCRIPTION	MAP	MSRP
F6PSPD30S1	30"	Stainless Steel	Professional Speed Oven	\$ 2,599	\$2,789

SOFIA - WARMING DRAWER

SOFIA
Professional Warming Drawer **600**

F6PWD30S1

30" Professional Warming Drawer
Series: 600
Available in 7 Finishes

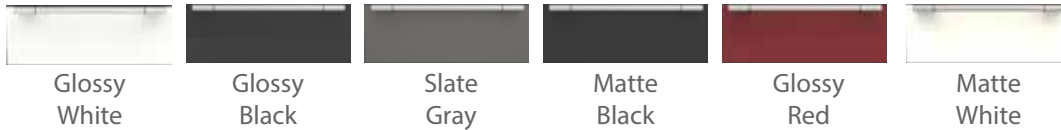
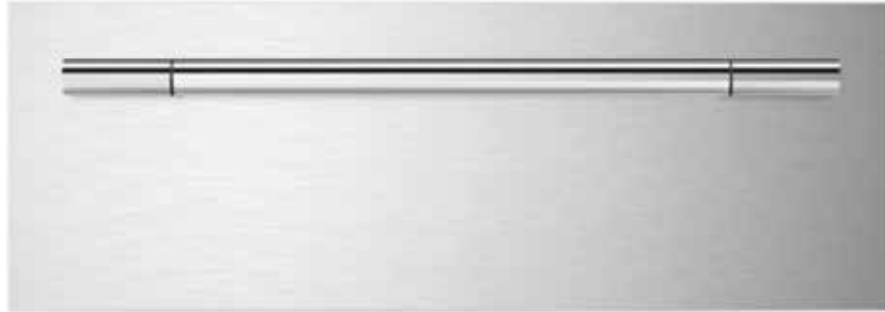

Features

- Knob Control
- Heavy Duty Full Extension Telescopic Rails
- Large Capacity, 2.1 CuFt
- Convection Heating System for Even Heat Distribution
- All Stainless Steel Construction
- Warming Temperature Range - 86°F - 190°F
- Slow Closing Drawer
- 2 Internal Lights
- Non-Slip Rubber Mat

Functions

- Pre-heat Dishes
- Pre-heat Coffee Cups
- Keep Food Warm
- Defrosting Dough
- Proofing Dough
- Slow Cooking - 86°F - 190°F

Product Information

MODEL	WIDTH	FINISH	DESCRIPTION	MAP	MSRP
F6PWD30S1	30"	Stainless Steel	Professional Warming Drawer	\$ 1,249	\$ 1,339

Optional Accessories

MODEL	DESCRIPTION	MAP	MSRP
PWDKIT30MG	Color Drawer Kit, Matte Slate Gray	\$ 279	\$ 299
PWDKIT30WH	Color Drawer Kit, Glossy White	\$ 279	\$ 299
PWDKIT30MW	Color Drawer Kit, Matte White	\$ 279	\$ 299
PWDKIT30RD	Color Drawer Kit, Glossy Red	\$ 279	\$ 299
PWDKIT30BK	Color Drawer Kit, Glossy Black	\$ 279	\$ 299
PWDKIT30MB	Color Drawer Kit, Matte Black	\$ 279	\$ 299

STOCK ITEMS ARE HILIGHTED

SOFIA DISHWASHERS

SOFIA
Professional 600
Dishwasher

F6DWT24
24" Dishwashers
Series: 600

SOFIA
BUILT-INS



Features

- Quiet Plus - 45 dB
- Stainless Steel Interior Tub
- 6 Wash Cycles
- Fast Function Wash Cycle
- Flexible Rack Loading
- 3rd Rack for Extra Capacity
- Filtering System
- Half Load Cycle
- 16 Place Settings
- Adjustable Feet
- Concealed Heating Element
- Adjustable Hinge System
- Extreme Wash (Sanitization)
- Must Order Handle Kit with Stainless Steel Model
- Optional Removable Logo Badge

Product Information

MODEL	WIDTH	FINISH	DESCRIPTION	MAP	MSRP
F6DWT24SS2	24"	Stainless Steel	Dishwasher	\$ 1,099	\$ 1,179
F6UHK24DISH	24"	Sofia	Sofia Handle and Badge Kit	\$ 99	\$ 104

More dishwasher options available on page 84



SOFIA REFRIGERATION

As beautiful as it is functional, the Sofia Professional Fridge and Wine Series features brushed stainless exteriors for maximum impact and a brilliant white aluminum interior. Food preservation is key so they combine the latest technologies to ensure the highest performance.

EXPLORE OUR BUILT-IN REFRIGERATOR



Extra Deep Storage Capacity

Brilliant White Aluminum and Stainless Steel Interior

Full-Extension Soft Close Drawers

Ice Maker with Adjustable Cube Size

FlexZone Bottom Drawer Refrigerator, Freezer or Fresco

Zero-Clearance, Heavy-Duty Stainless Steel Hinge System

Lateral Airflow Curtain

LED Lighting

Available in Stainless Steel and Panel-Ready options

Stainless Steel Crisper Drawers

Automatic Defrost System

SOFIA REFRIGERATION - BUILT-IN REFRIGERATOR

SOFIA REFRIGERATION

SOFIA Professional Refrigerator 700



Stainless Model
See previous page for interior details

Panel Ready Model

F7PBM36S1 & F7IBM36O1

36" Professional Refrigerator
Series: 700

Features

- Flexzone Bottom Drawer that can be converted to refrigerator, freezer or fresco
- Lateral Airflow Curtain
- Brilliant White Aluminum and Stainless Steel Interior
- Extra Deep Storage Capacity
- Automatic Defrost System
- Full Extension Stainless Steel Soft Close Drawers
- Filtered Ice Maker with Adjustable Cube Sizes
- LED Lighting
- Interior LED Digital Touch Interface
- Gas Emission Free
- Super Quiet 41 dB Noise Level
- Available in Stainless Steel and Panel Ready Options

Product Information

MODEL	WIDTH	FINISH	DESCRIPTION	MAP	MSRP
F7PBM36S1-L	36"	Stainless Steel	Professional Refrigerator, Left Hinge	\$ 8,999	\$ 9,649
F7PBM36S1-R	36"	Stainless Steel	Professional Refrigerator, Right Hinge	\$ 8,999	\$ 9,649
F7IBM36O1-L	36"	Panel Ready	Professional Refrigerator, Left Hinge	\$ 8,499	\$ 9,099
F7IBM36O1-R	36"	Panel Ready	Professional Refrigerator, Right Hinge	\$ 8,499	\$ 9,099

Optional Accessories

MODEL	DESCRIPTION	MAP	MSRP
REFSBSPRO60	Sofia 1-Piece Joining Kit (Incl. Joining Strip, 60" 1-Piece Upper Grill, Toe Kick and Insulated Blanket)	\$ 1,259	\$ 1,349
REFSBSPRO72	Sofia 1-Piece Joining Kit (Incl. Joining Strip, 72" 1-Piece Upper Grill, Toe Kick and Insulated Blanket)	\$ 1,349	\$ 1,449
REFSBSINT60	Joining Kit for Integrated Units	\$ 229	\$ 239
REFHANDPRO36	Sofia 36" Refrigerator PRO Handle for Overlay Model	\$ 419	\$ 449
REFHANDIS36	Distinto 36" Refrigerator Handle for Overlay Model	\$ 419	\$ 449

STOCK ITEMS ARE HILIGHTED

SOFIA REFRIGERATION - BUILT-IN WINE RESERVES

SOFIA
Professional 700
Wine Reserve

SOFIA REFRIGERATION

F7PBW24S1

24" Professional Wine Reserve
Series: 700

Features

- Flexzone Bottom Drawer that can be converted to refrigerator, freezer or fresco
- Upper Wine Compartment - 50°F - 64°F
- Lower Wine Compartment - 39°F - 55°F
- Cave Storage Top Compartment with Natural Wood Shelves for 36 Bottles
- Lateral Airflow Curtain
- Wine Cellar Bottom Compartment with Natural Wood Shelves for 18 Bottles
- Automatic Defrost System
- LED Lighting
- Brilliant White Aluminum Interior
- Available in Stainless Steel and Panel Ready Options



Stainless Version

Panel Ready Version

Product Information

MODEL	WIDTH	FINISH	DESCRIPTION	MAP	MSRP
F7PBW24S1-L	24"	Stainless Steel	Professional Wine Reserve, Left Hinge	\$ 10,099	\$ 10,829
F7PBW24S1-R	24"	Stainless Steel	Professional Wine Reserve, Right Hinge	\$ 10,099	\$ 10,829
F7IBW24O1-L	24"	Panel Ready	Professional Wine Reserve, Left Hinge	\$ 9,699	\$ 10,389
F7IBW24O1-R	24"	Panel Ready	Professional Wine Reserve, Right Hinge	\$ 9,699	\$ 10,389

Optional Accessories

MODEL	DESCRIPTION	MAP	MSRP
REFSBSPRO60	Sofia 1-Piece Joining Kit (Incl. Joining Strip, 60" 1-Piece Upper Grill, Toe Kick and Insulated Blanket)	\$ 1,259	\$ 1,349
REFHANDPRO24	Sofia 24" Refrigerator PRO Handle for Overlay Model	\$ 349	\$ 379
REFHANDIS24	Distinto 24" Refrigerator Handle Kit for Overlay Model	\$ 349	\$ 379

SOFIA REFRIGERATION - FREESTANDING REFRIGERATOR

SOFIA REFRIGERATION

F6FBM36S2

36" Professional Counter Depth Refrigerator
Series: 600

SOFIA
Professional 600
Freestanding Refrigerator

Features

- Duo Cycle Cooling
- Height Adjustable Glass Cantilever Shelves
- Blue Lights to Increase Produce Life
- Ion Fresh System
- Interactive Digital Display
- Sabbath Mode
- Automatic Ice Machine
- Interior Filtered Water Dispenser
- Large Bottom Freezer Drawer
- Large Pantry Drawer in Freezer
- Theater LED Lighting



Product Information

MODEL	WIDTH	FINISH	DESCRIPTION	MAP	MSRP
F6FBM36S2	36"	Stainless Steel	Freestanding Refrigerator	\$ 3,299	\$ 3,539
F6HK36FFBS	36"	Stainless Steel	Sofia Pro Handle and Badge Kit for Freestanding Refrigerator	\$ 299	\$ 329
F7HK36FFBS	36"	Stainless Steel	Distinto Handle Kit for Freestanding Refrigerator	\$ 229	\$ 249

*** MUST ORDER HANDLE KIT ***



DISTINTO COLLECTION BUILT-IN PRODUCTS

The Distinto Collection ovens offer performance you expect from professional products but with a sleek European design that will fit flush into your kitchen space. With three different series to choose from, you have a variety of ovens with different features, sizes and colors that will work within your budget.



CREACTIVE

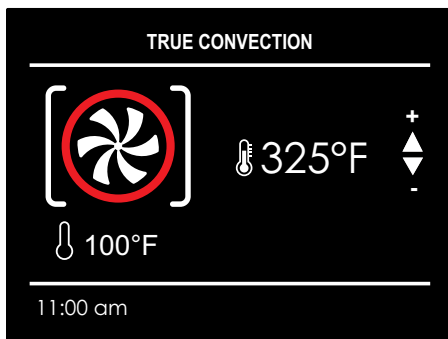

MULTI-LEVEL COOKING MODE
Internal heat remains constant throughout the oven, while smells and flavors are kept apart due to the fan assisted system.

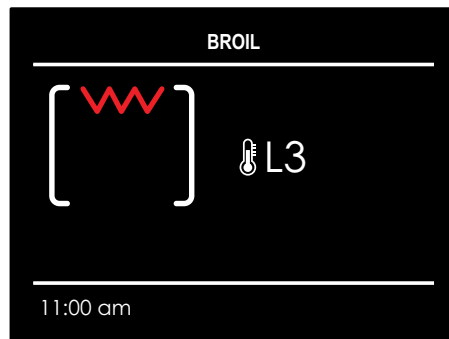

BROIL
The most effective way to brown or roast your meat in a short amount of time.

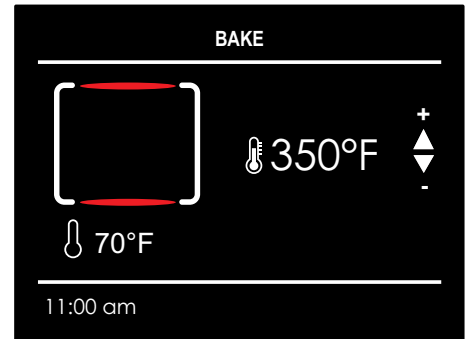

BAKE
Optimal for perfect baking: flavors blend effortlessly.

Creactive Control System

Our Creactive Control System featured on the 700 Series Built-In Wall Ovens, combines cutting edge technology with simplicity.

The touch screen simplifies all procedures and improves performance by reducing energy consumption while intensifying cooking modes. The automatic function system has safety features to warn against and prevent possible damages.

TOUCH CONTROL PANEL

Everything is under your control with just one touch on the Creative display.

INTUITIVE

It only takes a moment to easily find the desired function.

MULTITASKING

All functions help to get the best results while preparing your recipes.



PIZZA MODE 590 °F

Two pizzas can be cooked in only two and a half minutes at the same time with a maximum temperature of 590 °F.



CUSTOMIZABLE RECIPES

Cooking times and modes have been preprogrammed, but you can modify and customize your recipes to suit every palate and need.

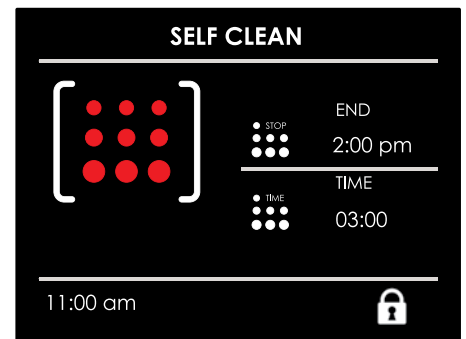

SELF-CLEANING

The pyrolytic self-clean function, selected directly from display, consists of heating the inside of the oven to very high temperatures in order to burn off any excess grease and food residue.

DISTINTO COLLECTION BUILT-IN OVENS - SINGLE - ELECTRIC

Series 700 Single Ovens



F7SP30

30" Touch Control Single Oven
Series: 700



Features

- Creactive Touch Control System
- Dual True Convection
- Self-Cleaning Oven with Multi-Function Baking
- Black Porcelain Enamel Interior
- Cool to Touch, Soft-Closing Door
- Extra-Large Baking Cavity and Viewing Area
- 3 Halogen Lights for Flawless Visibility
- Gross Capacity 4.4 cu. ft.
- 2 Chrome Racks
- 1 Telescopic Rack
- Enameled Broiler Pan
- Door Lock
- Available in 3 Finishes
- Perfect for Installation Under Cooktop

Finishes



Black Glass



White Glass



Stainless

Oven Functions

- Bake
- Broil
- Convection
- Recipes
- Classic Pizza Function 590 °F
- Preset / Last-Used Temperature Memory
- Automatic Fast Preheat
- Sabbath Mode
- Temperature Display °C/ °F
- Event Logs (for service)
- Meat Probe
- Self Clean
- Fast Preheat Mode
- Set Temperature and Weight
- Keep Warm

Product Information

MODEL	WIDTH	FINISH	DESCRIPTION	MAP	MSRP
F7SP30S1	30"	Stainless Steel	Single Electric Wall Oven	\$ 2,549	\$ 2,729
F7SP30B1	30"	Black Glass	Single Electric Wall Oven	\$ 2,499	\$ 2,679
F7SP30W1	30"	White Glass	Single Electric Wall Oven	\$ 2,499	\$ 2,679
FMTR630	30"		Telescopic Rack, 30"	\$ 169	\$ 179

STOCK ITEMS ARE HILIGHTED

DISTINTO COLLECTION BUILT-IN OVENS - DOUBLE - ELECTRIC

DISTINTO BUILT-INS



F7DP30

30" Touch Control Double Oven
Series: 700



Series 700
Double Ovens



Features

- Creative Touch Control System
- Dual True Convection
- Self-Cleaning Oven with Multi-Function Baking
- Black Porcelain Enamel Interior
- Cool to Touch, Soft-Closing Door
- Extra-Large Baking Cavity and Viewing Area
- 3 Halogen Lights for Flawless Visibility
- Gross Capacity 4.4 cu. ft.
- 2 Chrome Racks per Oven
- 1 Telescopic Rack per Oven
- Enameled Broiler Pan
- Door Lock
- Available in 3 Finishes

Oven Functions

- Bake
- Broil
- Convection
- Recipes
- Classic Pizza Function 590 ° F
- Preset / Last-Used
- Temperature Memory
- Set Temperature and Weight
- Automatic Fast Preheat
- Sabbath Mode
- Temperature Display °C/ °F
- Event Logs (for service)
- Meat Probe for Upper Oven
- Self Clean
- Fast Preheat Mode
- Keep Warm

Finishes



Black Glass



White Glass



Stainless

Product Information

MODEL	WIDTH	FINISH	DESCRIPTION	MAP	MSRP
F7DP30S1	30"	Stainless Steel	Double Electric Wall Oven	\$ 4,349	\$ 4,659
F7DP30B1	30"	Black Glass	Double Electric Wall Oven	\$ 4,249	\$ 4,549
F7DP30W1	30"	White Glass	Double Electric Wall Oven	\$ 4,249	\$ 4,549
FMTR630	30"		Telescopic Rack, 30"	\$ 169	\$ 179

DISTINTO COLLECTION BUILT-IN OVENS - SINGLE ELECTRIC

DISTINTO BUILT-INS



Series 700
Single Ovens

F7SP24S1
24" Self Clean Single Oven
Series: 700



NEW



Features

- Creactive Touch Control System
- Self Clean
- True Convection
- Black Porcelain Enamel Interior
- 1 Halogen Light
- Gross Capacity 2.6 CuFt
- 2 Chrome Racks
- 15 Cooking Functions
- Telescopic Rack
- Enameled Broiler Pan
- 1200W Broiler Element (240V)
- Perfect for Installation Under Cooktop
- Cool to Touch Door
- Door Safety Lock
- Boost Function for Rapid Pre-Heating
- Pre-Loaded Recipes that can be Customized
- Sabbath Mode

Oven Functions

- Bake
- Broil
- Convection Bake
- Convection Broil
- Convection Roast

Product Information

MODEL	WIDTH	FINISH	DESCRIPTION	MAP	MSRP
F7SP24S1	24"	Stainless Steel	Multi-Function Wall Oven, Self Oven	\$ 1,349	\$ 1,449

Optional Accessories

MODEL	DESCRIPTION	MAP	MSRP
FMTELG	24" Telescopic Oven Rack Guides	\$ 99	\$ 109

STOCK ITEMS ARE HILIGHTED

DISTINTO BUILT-INS

DISTINTO COLLECTION BUILT-IN OVENS - SINGLE ELECTRIC
AVAILABLE Q1 2022

Series **700**
Single Ovens

F7SM24S1
24" Easy Clean Single Oven
Series: 700



Features

- Touch Control System
- Easy Clean
- True Convection
- Black Porcelain Enamel Interior
- 1 Halogen Light
- Gross Capacity 2.6 CuFt
- 2 Chrome Racks
- Enameled Broiler Pan
- 1200W Broiler Element (240V)
- Perfect for Installation Under Cooktop
- Cool to Touch Door
- Pre-Loaded Recipes that can be Customized

Oven Functions

- Bake
- Broil
- Convection Bake
- Convection Broil
- Convection Roast

Product Information

MODEL	WIDTH	FINISH	DESCRIPTION	MAP	MSRP
F7SM24S1	24"	Stainless Steel	Multi-Function Wall Oven, Easy Oven	\$ 899	\$ 959

Optional Accessories

MODEL	DESCRIPTION	MAP	MSRP
FMTELG	24" Telescopic Oven Rack Guides	\$ 99	\$ 109

DISTINTO COLLECTION BUILT-IN OVENS - **STEAM OVEN**

Series 700
Single Ovens

F7DSCO30S1

24" & 30" Combi Convection Steam Oven
Series: 700



DISTINTO BUILT-INS

Features

- 3-in-1 Combi Oven (Steam, Convection or Combination)
- 12 Cooking Functions
- Removable Water Tank
- Quick Access Menu
- Steam Recovery System
- Easy Steam Cleaning Cycle
- Limescale Water Filter
- Stainless Steel Interior
- Cool Touch Door
- Interior Lighting
- 1.2 CuFt Capacity

Included

- Meat Probe
- 1 Micro-perforated Pan with Stainless Steel Cover
- 1 Stainless Steel Tray
- 1 Flat Rack

Product Information

MODEL	WIDTH	FINISH	DESCRIPTION	MAP	MSRP
F7SCO24S1	24"	Stainless Steel	Combi Convection Steam Oven	\$ 2,049	\$ 2,189
F7DSCO30S1	30"	Stainless Steel	Combi Convection Steam Oven	\$ 2,399	\$ 2,569

Optional Accessories

MODEL	DESCRIPTION	MAP	MSRP
F7DTK30S0	30" Trim Kit for Combination Steam Oven	\$ 359	\$ 389

STOCK ITEMS ARE HIGHLIGHTED

DISTINTO COLLECTION BUILT-IN OVENS - **SPEED OVEN**
AVAILABLE Q1 2022

Series **700**
Single Ovens

F7DSPD24S1/F7DSPD30S1
24" & 30" Combi Convection Speed Oven
Series: 700



DISTINTO BUILT-INS



Features

- 3-in-1 Combi Oven (Microwave, Convection or Combination)
- 10 Cooking Functions
- Quick Access Menu
- Microwave Mode includes 6 levels
- Stainless Steel Interior
- Cool Touch Door
- Interior Lighting
- 1.2 CuFt Capacity
- Grill Mode
- Defrosting by Time and Weight

Included

- Meat Probe
- 1 Micro-perforated Pan with Stainless Steel Cover
- 1 Stainless Steel Tray
- 1 Flat Rack

Product Information

MODEL	WIDTH	FINISH	DESCRIPTION	MAP	MSRP
F7DSPD24S1	24"	Stainless Steel	Combi Convection Speed Oven	\$ 1,829	\$ 1,959
F7DSPD30S1	30"	Stainless Steel	Combi Convection Speed Oven	\$ 2,149	\$ 2,299

DISTINTO COLLECTION BUILT-IN OVENS - SINGLE - ELECTRIC

Series 400
Single Ovens

DISTINTO BUILT-INS



F4SP30S3

30" Multi-Function Self-Clean Oven
Series: 400



Features

- Knob and Electronic Controls
- Single Fan True Convection
- Self-Cleaning Oven with Multi-Function Baking
- Black Porcelain Enamel Interior
- Cool to Touch Door
- Extra-Large Baking Cavity and Viewing Area
- 3 Halogen Lights for Flawless Visibility
- Gross Capacity 4.4 cu. ft.
- 2 Chrome Racks
- Enameled Broiler Pan
- Perfect for Installation Under Cooktop

Oven Functions

- Bake
- Broil
- Thaw (Defrost)
- Self Clean
- Dehydrate
- Cooking Programmer
- Convection Bake
- Convection Broil
- Convection Roast
- Convection
- True Convection
- Sabbath Mode

Product Information

MODEL	WIDTH	FINISH	DESCRIPTION	MAP	MSRP
F4SP30S3	30"	Stainless Steel	Multi-Function Wall Oven, Self Clean	\$ 1,899	\$2,039

Optional Accessories

MODEL	DESCRIPTION	MAP	MSRP
FMTR630	30" Telescopic Oven Guides	\$ 169	\$ 179

STOCK ITEMS ARE HILIGHTED

DISTINTO COLLECTION BUILT-IN OVENS - SINGLE - ELECTRIC

DISTINTO BUILT-INS

Series 100
Single Ovens

F1SP30S3 & F1SM30S3

30" Multi-Function Ovens
Series: 100



Features - F1SP30S3

- Self-Cleaning Oven with Multi-Function Baking
- Knob and Electronic Controls
- True Convection
- Black Porcelain Enamel Interior
- 2 Halogen Lights
- Gross Capacity 3.0 cu. ft.
- 2 Chrome Racks
- Enameled Broiler Pan
- 3100W Broiler Element (240V)
- LED Clock/Timer Display
- Perfect for Installation Under Cooktop
- 30" x 24" Space Saving Design

Features - F1SM30S3

- Easy Clean Oven with Multi-Functional Baking
- Knob and Electronic Controls
- True Convection
- Black Porcelain Enamel Interior
- 2 Halogen Lights
- Gross Capacity 3.0 cu. ft.
- 2 Chrome Racks
- Enameled Broiler Pan
- 3100W Broiler Element (240V)
- Perfect for Installation Under Cooktop
- LED Clock/Timer Display
- 30" x 24" Space Saving Design

Oven Functions

- | | |
|--|--|
| <ul style="list-style-type: none"> • Bake • Broil • Thaw (Defrost) • Self Clean (Only on F1SP30S3) | <ul style="list-style-type: none"> • Convection Bake • Convection Broil • Convection Roast • Lower Convection Bake |
|--|--|

Product Information

MODEL	WIDTH	FINISH	DESCRIPTION	MAP	MSRP
F1SP30S3	30"	Stainless Steel	Multi-Function Wall Oven, Self Clean	\$ 1,599	\$ 1,719
F1SM30S3	30"	Stainless Steel	Multi-Function Wall Oven, Easy Clean	\$ 1,199	\$ 1,289

Optional Accessories

MODEL	DESCRIPTION	MAP	MSRP
FMTR130	30" Telescopic Oven Rack	\$ 169	\$ 179

DISTINTO COLLECTION BUILT-IN OVENS - SINGLE - ELECTRIC

DISTINTO BUILT-INS

Series 100
Single Ovens

F1SM24S2

24" Multi-Function Easy-Clean Oven
Series: 100



Features

- Knob and Electronic Controls
- True Convection
- Black Porcelain Enamel Interior
- 1 Halogen Light
- Gross Capacity 2.6 cu. ft.
- 2 Chrome Racks
- Enameled Broiler Pan
- 1200W Broiler Element (240V)
- Perfect for Installation Under Cooktop
- LED Clock/Timer Display

Oven Functions

- Bake
- Broil
- Convection Bake
- Convection Broil
- Convection Roast
- Lower Convection Bake



Product Information

MODEL	WIDTH	FINISH	DESCRIPTION	MAP	MSRP
F1SM24S2	24"	Stainless Steel	Multi-Function Wall Oven, Easy Clean	\$ 679	\$ 729

Optional Accessories

MODEL	DESCRIPTION	MAP	MSRP
FMTELG	24" Telescopic Oven Rack Guides	\$ 99	\$ 109

STOCK ITEMS ARE HIGHLIGHTED

DISTINTO COLLECTION - WARMING DRAWERS

DISTINTO BUILT-INS

Series 700
Warming Drawers

WD24 & WD30
24" & 30" Warming Drawer
Series: 400 & 700



NEW



Features - 24"

- Stainless Steel Construction
- Non-Slip Rubber Mat
- Interior Lighting
- Fan Assisted
- Knob Controlled
- Adjustable Thermostat
- Warming Temperature Range - 86°F - 190°F
- Push-Pull System to Open and Close Door
- Full Extension Telescopic Rails
- 6" Height

Features - 30"

- Stainless Steel Construction
- Knob Control
- Full Extension Telescopic Rails
- Large Capacity, 2.1 CuFt
- Convection Heating System for Even Heat Distribution
- Warming Temperature Range - 86°F - 190°F
- Push-Pull System to Open and Close Door
- Interior Lighting
- Non-Slip Rubber Mat
- Available in Stainless Steel and Panel Ready Models
- 10" Height

Functions

- Pre-heat Dishes
- Pre-heat Coffee Cups
- Keep Food Warm
- Defrosting
- Proofing Dough
- Slow Cooking - 86°F - 190°F

Product Information

MODEL	WIDTH	HEIGHT	FINISH	DESCRIPTION	MAP	MSRP
F4DWD24S1	24"	6"	Stainless Steel	Warming Drawer	\$ 899	\$ 969
F7DWD30S1	30"	10"	Stainless Steel	Warming Drawer	\$ 1,049	\$ 1,129
F71WD3001	30"	10"	Panel Ready	Warming Drawer	\$ 999	\$ 1,069

DISTINTO COLLECTION BUILT-IN PRODUCTS - COFFEE MACHINE

Features

- Whole Bean Coffee Grinder
- 13 Brewing Functions
- Touch Control Panel
- Dual Dispensing
- Adjustable Coffee Strength and Grinder Settings
- Fast 3 Minute Heating
- Automatic Cleaning Cycle
- Incuded Milk Froth Pitcher
- Removable Water Tank

Function

- 3 Coffee Temperature Settings
- 5 Coffee Strength Settings
- 5 Mug Size Settings
- Steam and Frothing
- Telescopic Easy Clean Access
- Stand-by (Energy Saving) Mode

Safety

- Water hardness setting
- Coffee and water refill indicators
- One Touch Cleaning Cycle
- Limescale Filter
- Empty Coffee Grounds Indicator

F7BC

24" Built-In Coffee Machine
Series: 700



30" TRIM KITS



F7DTK30BC



F6DTK30BC

Product Information

MODEL	WIDTH	FINISH	DESCRIPTION	MAP	MSRP
F7BC24S1	24"	Stainless Steel	Built-In Coffee Machine	\$ 2,999	\$ 3,219
F7BC24B1	24"	Black Glass	Built-In Coffee Machine	\$ 2,929	\$ 3,139

Optional Accessories

MODEL	DESCRIPTION	MAP	MSRP
F7DTK30BC	30" Distinto Trim Kit for Black Unit Only (F7BC24B1)	\$ 569	\$ 619
F6DTK30BC	30" Professional Trim Kit for Black Unit Only (F7BC24B1)	\$ 569	\$ 619

STOCK ITEMS ARE HILIGHTED

DISTINTO COLLECTION MICROWAVE OVENS - DRAWER UNIT

Series 700
Microwave Ovens

F7DMW24S2
24" Microwave Oven Drawer Unit
Series: 700



DISTINTO MICROWAVES



Features

- Stainless Steel Design
- LED Interior Lighting
- Touch Glass Control Panel
- Accessible Height to Easily Remove Hot Food
- Built-In Airflow Control for Flush Installation
- Transparent Glass Door
- 1.2 CuFt Capacity
- 950 Watt Power
- 11 Power Levels
- Flexible Installation

Product Information

MODEL	WIDTH	FINISH	DESCRIPTION	MAP	MSRP
F7DMW24S2	24"	Stainless Steel	Microwave Oven Drawer Unit	\$ 1,399	\$ 1,499

DISTINTO COLLECTION MICROWAVE OVENS - COUNTERTOP / BUILT-IN

DISTINTO MICROWAVES

F4MWO24S1

24" Countertop or Built-In Microwave Oven
Series: 400



Series 400

Microwave Ovens

Features

- Family Size
- 2.0 CuFt Capacity
- 1100 Watt Power
- 11 Power Levels
- Push Button Opener
- Electronic Touch Control
- Super Defrost
- Sensor Cook Menu
- Auto Start
- Child Lock
- 4 Program Stages



Product Information

MODEL	WIDTH	FINISH	DESCRIPTION	MAP	MSRP
F4MWO24S1	24"	Stainless Steel	Countertop or Built-In Microwave Oven	\$ 489	\$ 519

Optional Accessories

MODEL	DESCRIPTION	MAP	MSRP
F4TK30MWO	30" Stainless Steel Trim Kit for Microwave Oven	\$ 419	\$ 449

STOCK ITEMS ARE HILIGHTED

DISTINTO COLLECTION MICROWAVE OVENS - OVER THE RANGE

DISTINTO MICROWAVES

Series **400**
Microwave Ovens

F4OTR30S1
30" OTR Microwave Oven
Series: 400



Features

- 1.8 CuFt Capacity
- 1100 Watt Power
- 10 Power Levels
- LED Display
- LED Lighting
- Recessed Cavity
- Child-Safe Lock-Out Feature
- Removable Glass Turntable
- 450 CFM
- Ducted or Recirculating Installation
- Charcoal Filter Included

Microwave Functions

- 4 Sensor Cook Menu
- 2 Programmed Menus (Beverage, Popcorn)
- 4 Soften/Melt Menus (Butter, Chocolate, Ice Cream, Cheese)
- 6 Convenience Features (Turntable On/Off, Clock, Keep Warm, Time Cook, Power Level, Defrost Express Cook (1-6 Minutes)
- Kitchen Timer

Product Information

MODEL	WIDTH	FINISH	DESCRIPTION	MAP	MSRP
F4OTR30S1	30"	Stainless Steel	OTR Microwave Oven	\$ 579	\$ 619

DISTINTO COLLECTION COOKTOPS

Fulgor Milano cooktops embody Italian elegance and design while offering the quality and durability expected from one of Europe's leading manufacturers of built-in cooking appliances.



STOCK ITEMS ARE HILIGHTED

DISTINTO COLLECTION COOKTOPS - RADIANT

Series 600
Radiant Cooktops

F6RT30S2 & F6RT36S2 ⚡
30" & 36" Radiant Cooktop
Series: 600

DISTINTO COOKTOPS



F6RT30S2



F6RT36S2

Features

- 4 Cooking Zones - 30"
- 5 Cooking Zones - 36"
- Bridge Zone - 36"
- Digital Display for Power Level
- Low Power Scale for Delicate Cooking
- Control Lock
- Automatic Fast-Boil Function
- Independent Timer for Each Zone
- Easy Clean Textured Glass Surface
- Power and Hot Surface Indication
- Timer Functions
- Timer Display
- Acoustic Buzzer
- Brushed Aluminum Trim
- Booster Function for Each Cooking Zone

Product Information

MODEL	WIDTH	FINISH	DESCRIPTION	MAP	MSRP
F6RT30S2	30"	Stainless Steel	Radiant Cooktop	\$ 929	\$ 999
F6RT36S2	36"	Stainless Steel	Radiant Cooktop	\$ 1,099	\$ 1,179

DISTINTO COLLECTION COOKTOPS - INDUCTION

DISTINTO COOKTOPS

Series 700
Induction Cooktops

F7IT30S1 & F7IT36S1

30" & 36" Induction Cooktop
Series: 700



F7IT30S1



F7IT36S1

Features

- 4 Cooking Zones - 30"
- 5 Cooking Zones - 36"
- Bridge Zone - 36"
- Easy Clean Textured Ceramic Glass Surface
- 11" Cooking Zone
- Premium Induction Technology for Unsurpassed Performance
- Independent Timer for Each Zone
- Melting and Warming Functions
- Residual Heat and Power on Indicators
- Pan and Pot Detection System
- Child Lock Function
- Booster Function for each Cooking Zone
- Digital Display for Power Level
- Elegant Aluminum Trim
- Pause Function
- Automatic Fast-Boil Function

Product Information

MODEL	WIDTH	FINISH	DESCRIPTION	MAP	MSRP
F7IT30S1	30"	Stainless Steel	Induction Cooktop	\$ 1,599	\$ 1,719
F7IT36S1	36"	Stainless Steel	Induction Cooktop	\$ 2,099	\$ 2,249

Optional Accessories

MODEL	DESCRIPTION	MAP	MSRP
INDUKIT4	Induction Plate Kit, 4 Piece	\$ 139	\$ 149

Series 400
Gas Cooktops

F4GK24S1
24" Gas Cooktop
Series: 400



Features

- 4 Burners with (1) 18,000 BTU Crescendo Burner
- Standard NG, LP Conversion Kit Included
- Electronic Re-Ignition System
- Flame-Out Sensor
- Heavy Duty Cast Iron Continuous Grates

Product Information

MODEL	WIDTH	FINISH	DESCRIPTION	MAP	MSRP
F4GK24S1	24"	Stainless Steel	Gas Cooktop	\$ 729	\$ 789

Optional Accessories

MODEL	DESCRIPTION	MAP	MSRP
FMSPR	Small Pot Insert/Reducer, Single Burner	\$ 49	\$ 54
FMSIM	Simmer Plate, Single Burner	\$ 69	\$ 74
FMWOK	Wok Ring, Dual Burner	\$ 55	\$ 59

DISTINTO COLLECTION COOKTOPS - GAS

Series 400
Gas Cooktops

F4GK30S1
30" Gas Cooktop
Series: 400



Features

- 5 Burners with (1) 18,000 Crescendo BTU Burner
- Standard NG, LP Conversion Kit Included
- Electronic Re-Ignition System
- Flame-Out Sensor
- Heavy Duty Cast Iron Continuous Grates

Product Information

MODEL	WIDTH	FINISH	DESCRIPTION	MAP	MSRP
F4GK30S1	30"	Stainless Steel	Gas Cooktop	\$ 879	\$ 939

Optional Accessories

MODEL	DESCRIPTION	MAP	MSRP
FMSPR	Small Pot Insert/Reducer, Single Burner	\$ 49	\$ 54
FMSIM	Simmer Plate, Single Burner	\$ 69	\$ 74
FMWOK	Wok Ring, Dual Burner	\$ 55	\$ 59

STOCK ITEMS ARE HILIGHTED

DISTINTO COLLECTION COOKTOPS - GAS

Series 400
Gas Cooktops

F4GK36S1
36" Gas Cooktop
Series: 400



DISTINTO COOKTOPS

Features

- 5 Burners with (1) 18,000 BTU Crescendo Burner
- NG, LP Conversion Kit Included
- Electronic Re-Ignition System
- Flame-Out Sensor
- Heavy Duty Cast Iron Continuous Grates

Product Information

MODEL	WIDTH	FINISH	DESCRIPTION	MAP	MSRP
F4GK36S1	36"	Stainless Steel	Gas Cooktop	\$ 949	\$ 1,049

Optional Accessories

MODEL	DESCRIPTION	MAP	MSRP
FMSPR	Small Pot Insert/Reducer, Single Burner	\$ 49	\$ 54
FMSIM	Simmer Plate, Single Burner	\$ 69	\$ 74
FMWOK	Wok Ring, Dual Burner	\$ 55	\$ 59

DISTINTO COLLECTION COOKTOPS - GAS

DISTINTO COOKTOPS

Series 400
Gas Cooktops

F4GK42S1
44" Gas Cooktop
Series: 400



Features

- 4 Burners with (1) 18,000 BTU Crescendo Burner
- NG, LP Conversion Kit Included
- Electronic Re-Ignition System
- Flame-Out Sensor
- Heavy Duty Cast Iron Continuous Grates

Product Information

MODEL	WIDTH	FINISH	DESCRIPTION	MAP	MSRP
F4GK42S1	44"	Stainless Steel	Gas Cooktop	\$ 999	\$ 1,069

Optional Accessories

MODEL	DESCRIPTION	MAP	MSRP
FMSPR	Small Pot Insert/Reducer, Single Burner	\$ 49	\$ 54
FMSIM	Simmer Plate, Single Burner	\$ 69	\$ 74
FMWOK	Wok Ring, Dual Burner	\$ 55	\$ 59

STOCK ITEMS ARE HIGHLIGHTED

DISTINTO COLLECTION COOKTOPS - RADIANT

Series 300
Radiant Cooktops

F3RK24S2
24" Radiant Cooktop
Series: 300



DISTINTO COOKTOPS

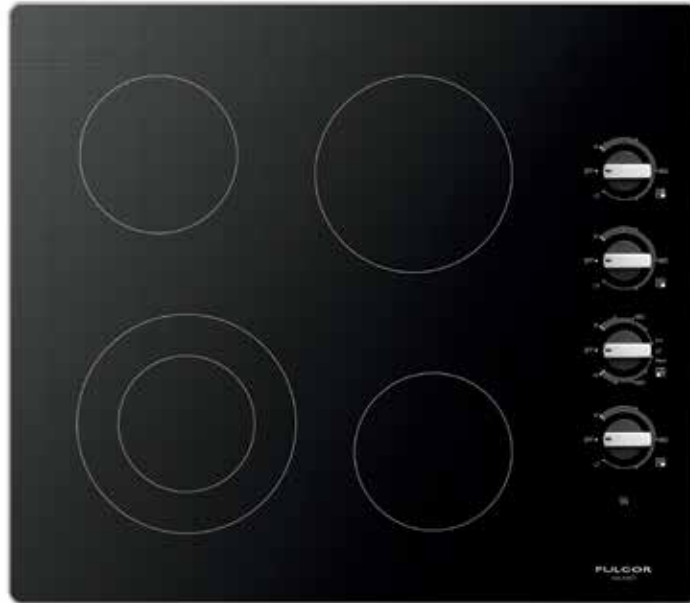

Features

- 4 Cooking Zones
- Power on Indication
- Hot Surface Indication
- Easy Clean Ceramic Glass
- Residual Heat Sensor
- Double Radiant Cooking Zone
- Brushed Aluminum Trim

Product Information

MODEL	WIDTH	FINISH	DESCRIPTION	MAP	MSRP
F3RK24S2	24"	Stainless Steel	Radiant Cooktop	\$ 779	\$ 829

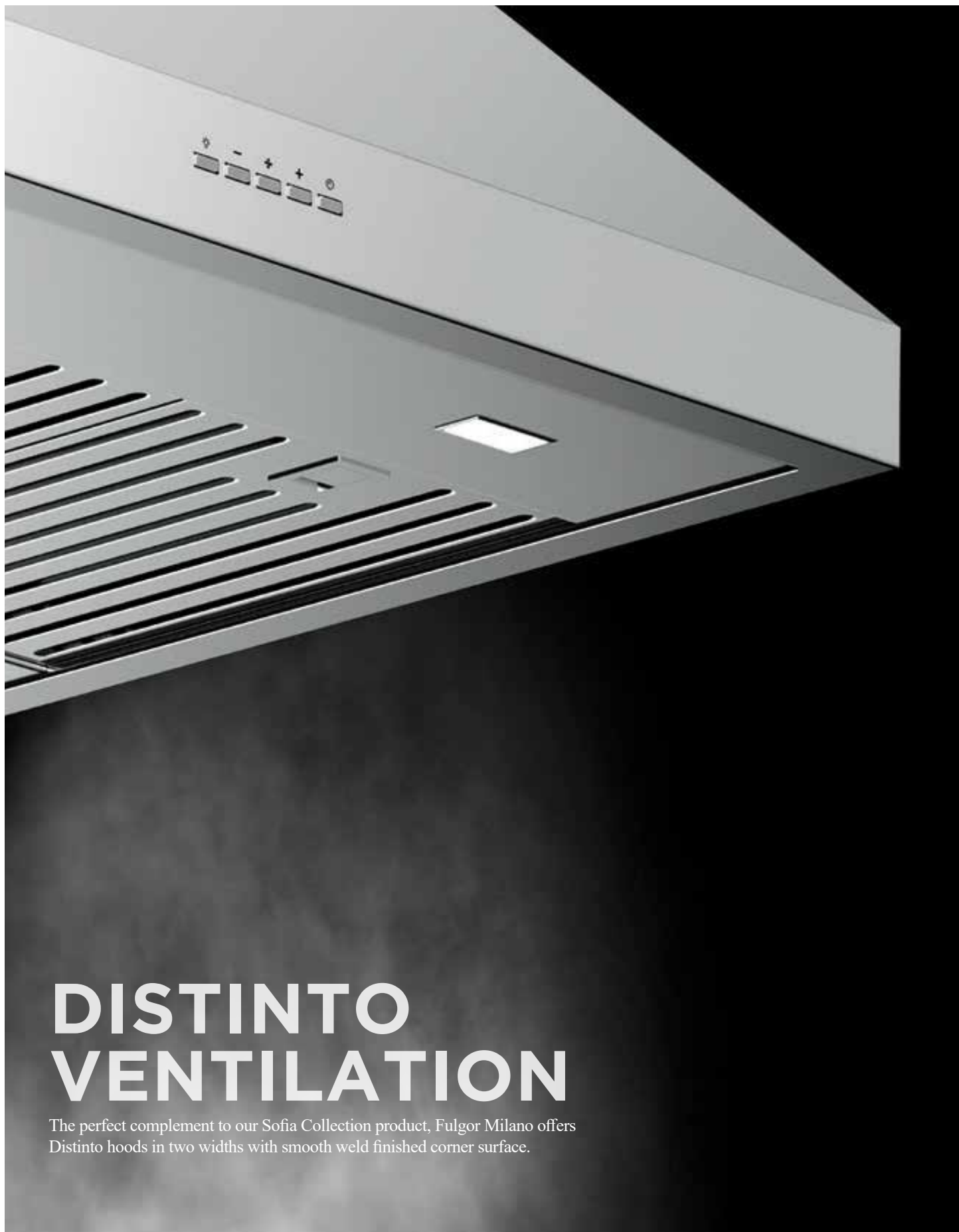

DISTINTO VENTILATION

The perfect complement to our Sofia Collection product, Fulgor Milano offers Distinto hoods in two widths with smooth weld finished corner surface.

DISTINTO COLLECTION HOODS - HOOD

Series 400
Hoods

F4CW30 & F4CW36

30" & 36" Wall Mount Chimney Hood
Series: 400



Features

- Scotch Brite 304 Stainless Steel
- Electronic Controls
- 4 Speed Settings
- LED Lighting
- Baffle Filter
- 600 CFM
- Optional Recirculating Kit
- Adjustable Duct Extension for up to 9' Ceilings

Product Information

MODEL	WIDTH	FINISH	CFM	DESCRIPTION	MAP	MSRP
F4CW30S1	30"	Stainless Steel	600	Baffle Filter Hood	\$ 1,199	\$ 1,279
F4CW36S1	36"	Stainless Steel	600	Baffle Filter Hood	\$ 1,249	\$ 1,339

Optional Accessories

MODEL	DESCRIPTION	MAP	MSRP
FMFILCW	Square Charcoal Filter	\$ 29	\$ 33
KACL.512#1	Duct Extension - 38"	\$ 191	\$ 218
KACL.510#1	Duct Extension - 27"	\$ 187	\$ 213

DISTINTO COLLECTION HOODS - INSERT HOOD

Series **400**
Hoods
F4BP28S1
28" Insert Hood
Series: 400



Series **600**
Hoods
F6BP34S1
34" Insert Hood
Series: 600



Features

- Scotch Bright Stainless Steel
- 600 CFM
- LED Lighting
- Cast Aluminum Motor Body
- Professional Baffle Filter
- Ceiling Installation

Product Information

MODEL	WIDTH	FINISH	DESCRIPTION	MAP	MSRP
F4BP28S1	28"	Stainless Steel	Insert Hood	\$ 799	\$ 859
F6BP34S1	34"	Stainless Steel	Insert Hood	\$ 1,199	\$ 1,289

Optional Accessories

MODEL	DESCRIPTION	MAP	MSRP
FMFIL	Round Carbon Recirculating Filter	\$ 59	\$ 59

STOCK ITEMS ARE HILIGHTED

DISTINTO COLLECTION HOODS - UNDER CABINET HOOD

Series **400**
Hoods

F4UC30S1 & F4UC36S1

30" & 36" Under Cabinet Hood
Series: 400

DISTINTO VENTILATION



F4UC30S1



F4UC36S1

Features

- 450 CFM
- LED Lighting
- Baffle Filter

Product Information

MODEL	WIDTH	FINISH	DESCRIPTION	MAP	MSRP
F4UC30S1	30"	Stainless Steel	Under Cabinet Hood	\$ 999	\$ 1,079
F4UC36S1	36"	Stainless Steel	Under Cabinet Hood	\$ 1,099	\$ 1,179

Optional Accessories

MODEL	DESCRIPTION	MAP	MSRP
FMFIL	Round Carbon Recirculating Filter	\$ 59	\$ 59

FULGOR

MILANO

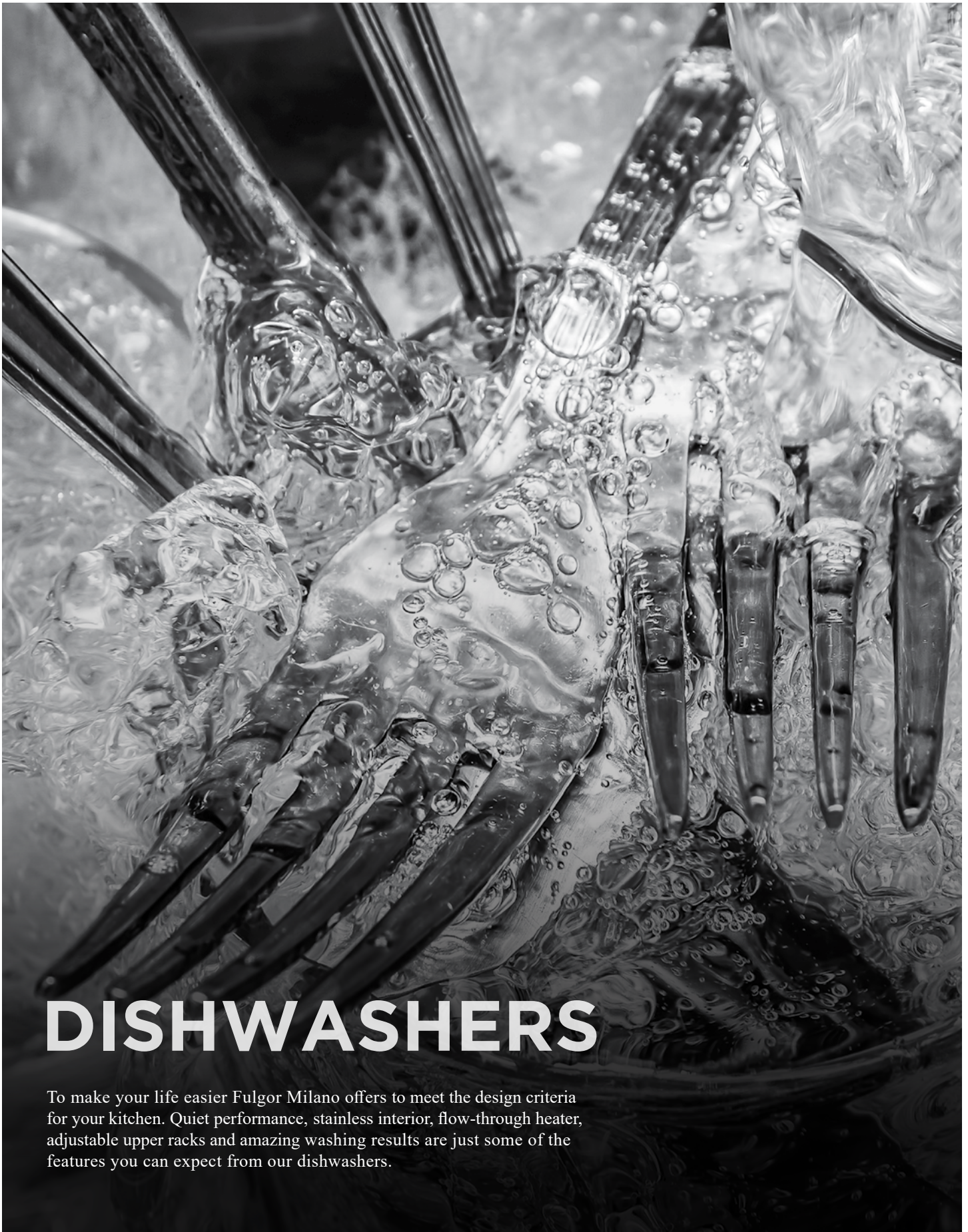

DISHWASHERS

To make your life easier Fulgor Milano offers to meet the design criteria for your kitchen. Quiet performance, stainless interior, flow-through heater, adjustable upper racks and amazing washing results are just some of the features you can expect from our dishwashers.

STOCK ITEMS ARE HILIGHTED

SOFIA DISHWASHERS

SOFIA
Professional Dishwasher 600

F6DWT
24" Dishwashers
Series: 600

SOFIA
DISHWASHER



Features

- Quiet Plus - 45 dB
- Stainless Steel Interior Tub
- 6 Wash Cycles
- Fast Function Wash Cycle
- Flexible Rack Loading
- 3rd Rack for Extra Capacity
- 16 Place Settings
- Filtering System
- Half Load Cycle
- Adjustable Feet
- Concealed Heating Element
- Adjustable Hinge System
- Extreme Wash (Sanitization)
- Must Order Handle Kit with Stainless Steel Model

Product Information

MODEL	WIDTH	FINISH	DESCRIPTION	MAP	MSRP
F6DWT24SS2	24"	Stainless Steel	Dishwasher	\$ 1,179	\$ 1,259
F6UHK24DISH	24"	Sofia	Sofia Handle and Badge Kit	\$ 99	\$ 104
F7HK24DISHS	24"	Distinto	Distinto Handle Kit*	\$ 69	\$ 74

DISTINTO DISHWASHERS
AVAILABLE Q4 2021

Series 400

Dishwashers

F4DWT

24" Dishwashers
 Series: 400



Features

- Quiet Plus - 49 dB
- Stainless Steel Interior Tub
- 6 Wash Cycles
- Flexible Rack Loading
- 14 Place Settings
- Super Active Drying
- Fully Built-In
- Top Control
- Adjustable Feet
- Concealed Heating Element
- Adjustable Hinge System
- 2 Foldable Racks
- Upper Basket
- Advanced Filtering system

Product Information

MODEL	WIDTH	FINISH	DESCRIPTION	MAP	MSRP
F4DWT24FI1	24"	Overlay	Dishwasher	\$ 779	\$ 839
F4DWT24SS1	24"	Stainless Steel	Dishwasher	\$ 849	\$ 909
F6UHK24DISH	24"	Sofia	Sofia Handle and Badge Kit	\$ 99	\$ 104
F7HK24DISHS	24"	Distinto	Distinto Handle Kit*	\$ 69	\$ 74

STOCK ITEMS ARE HILIGHTED

DISTINTO ADA DISHWASHERS
AVAILABLE Q4 2021

Series 400
Dishwashers

F4DWS

18" & 24" Dishwashers
Series: 400

NEW



DISTINTO DISHWASHERS

Features

- ADA Compliant
- Quiet Plus - 49 dB
- Stainless Steel Interior Tub
- 6 Wash Cycles
- Flexible Rack Loading
- 6 Place Settings
- Super Active Drying
- Fully Built-In
- Top Control
- Adjustable Feet
- Concealed Heating Element
- Adjustable Hinge System
- 2 Foldable Racks
- Upper Basket
- Advanced Filtering system

Product Information

MODEL	WIDTH	FINISH	DESCRIPTION	MAP	MSRP
F4DWS18FI1 <i>*Special Order Only</i>	18"	Overlay	Dishwasher	\$ 799	\$ 859
F4DWS24FI1	24"	Overlay	Dishwasher	\$ 779	\$ 839

LINE DRAWING MAP FOR PROFESSIONAL BUILT-IN OVENS SINGLE AND DOUBLE

A.

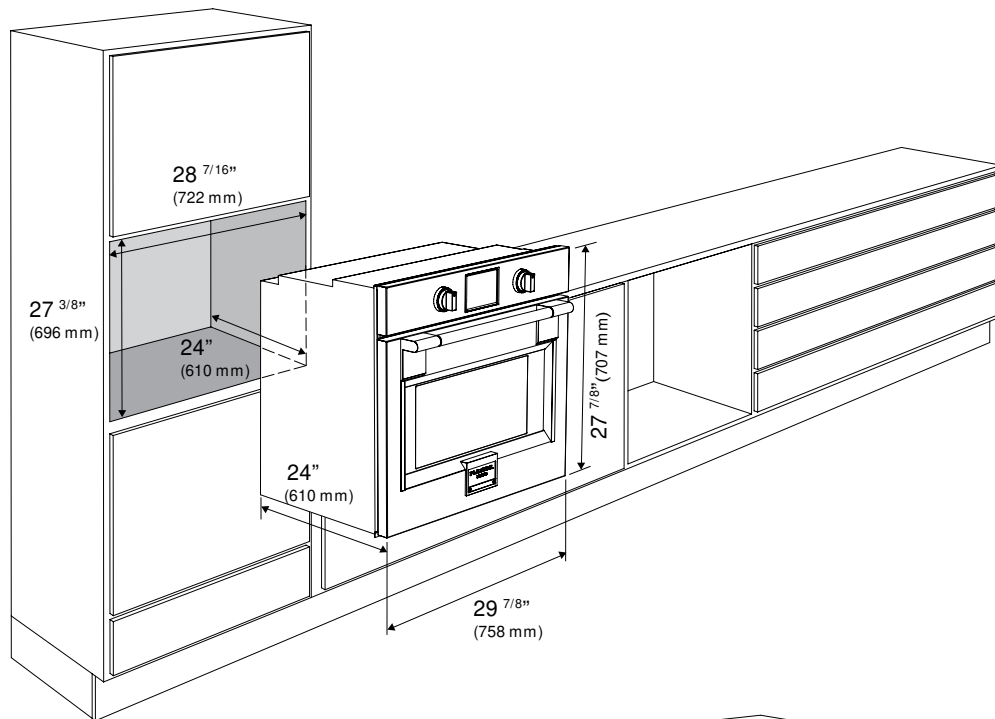

B.

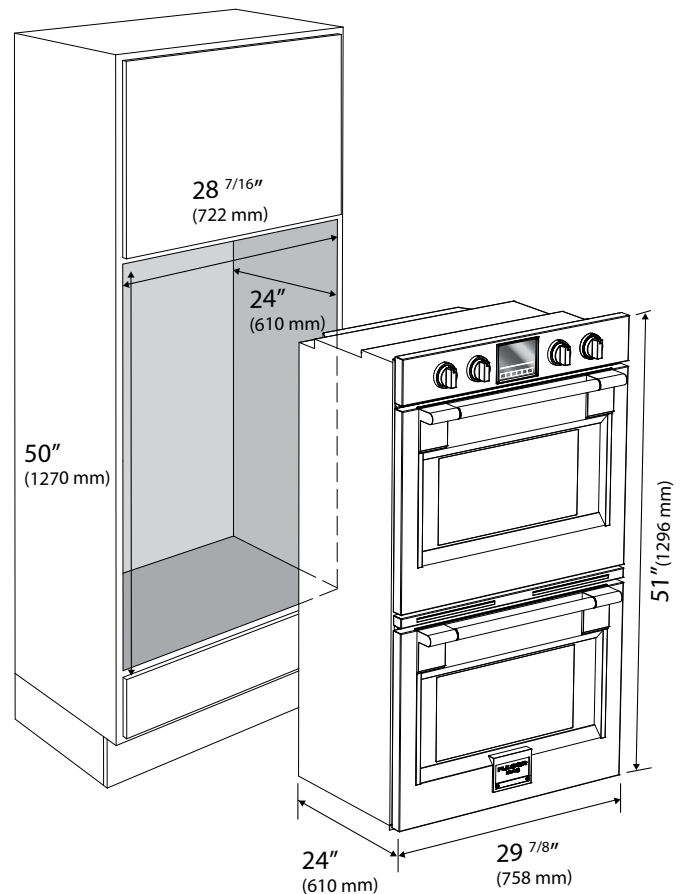

A. F6PSP30S1 (p.17)
30" Professional Single Oven
Series: 600

B. F6PDP30S1 (p.18)
30" Professional Double Oven
Series: 600

Warranty Class	Description of Warranty Coverage
0	Doors, handles, glass, product frames, racking, interior and exterior surfaces are covered by a limited 30-day parts-only warranty for cosmetic defects proven to have originated from the factory. It is the responsibility of the owner to inspect the product and report any such claims within this 30 day period.
1	1 year parts and labor
2	2 years parts and labor
5	5 years parts and labor on the following sealed system components only: compressor, condenser, evaporator, dryer and connective tubing
5p	5 years parts only on the following sealed system components only: compressor, condenser, evaporator, dryer and connective tubing
12p	12 years parts only on the following sealed system components only: compressor, condenser, evaporator, dryer and connective tubing

Product Class	Applicable Warranties	For proof of warranty, please retain the original purchase invoice and the delivery slip. To obtain service under these warranties you must: 1. Contact Maple Distributing Authorized Service a. By email at support@mapledistributing.com b. Toll free at 800-866-4774. 2. Provide a copy of your original sales receipt along with model number and serial number information for the product. 3. Provide Fulgor Milano reasonable opportunity to investigate the claim before the product or any component of the product has been modified or removed.
Cooking		
Drop-in Cooktops	0,2	
Built-in Ovens	0,2	
Range Tops	0,2	
Microwaves	0,1	
Freestanding Ranges	0,2	
Cleaning		
Dishwashers	0,2	
Cooling		
Built-in (700 series) Refrigeration and Wine	0,2,5,12p	
All Other Refrigeration	0,1,5p	
Ventilation		
Ventilation Hoods	0,2	

TERMS APPLICABLE TO THESE WARRANTIES

All applicable warranties for each class run concurrently. In accordance to the applicable warranty class, Fulgor Milano warranty covers all parts and / or labor to repair or replace, under normal residential use, any part of the product proving to be defective in material or workmanship as a result of the original manufacturing process. These warranties is valid only in the contiguous states of the U.S.A. including the District of Columbia and Alaska and the country of Canada. These warranties apply to the original purchaser only and are non-transferable. All service provided by Fulgor Milano under the applicable warranty must be performed by a Fulgor Milano authorized servicer unless otherwise specified in writing by Fulgor Milano. Service will be provided during the regular business hours of each specific region.

These warranties apply only to products purchased from an authorized dealer through an approved distribution chain and which are installed for normal residential use and do not apply to commercial use or use on yachts. These warranties only cover service performed at the location of product installation and will not cover costs associated with repairing off-site unless expressly authorized by Fulgor Milano nor does it cover the travel costs associated with providing service to remote locations. Remote locations are defined as being outside of a 50 mile (80 kilometre) radius from any authorized 'brick and mortar' dealer. These warranties do not cover any parts or labor needed to correct any defect caused by negligence, transport, delivery, improper voltage or accident or improper use, maintenance, installation, service or repair, including but not limited to improper removal and reinstallation of any component of the product (ie. removing handles to fit through doors) prior to or during product delivery / installation. The remedies described herein are the only ones which Fulgor Milano will provide, either under these warranties or under any warranty arising by operation of law. Fulgor Milano will not be responsible for content loss due to spoilage, freezing or burning nor for consequential damages to surrounding cabinetry, construction materials or finishing materials such as but not limited to flooring. Fulgor Milano will not be responsible for any consequential or incidental damages arising from the breach of these warranties or any other warranties, whether express, implied or statutory.

The warranty will be valid and effective only upon presentation of the document stating the purchase date of the appliance, and more specifically of the relevant invoice, proof of purchase or equivalent document showing the name of the seller, the delivery date and the identification data of the appliance (such as; model number and serial number). In the case of new product being included in the purchase of new residential construction; these warranties apply to the original resident of the location containing the Fulgor Milano product and warranty coverage will begin on the date of occupancy of the residence (proof of occupancy required) to a maximum additional six months from the date of delivery of the product by the development company from the distributor or dealer. This extension does not apply to the Class 0 cosmetic warranty.

These warranties are only valid where the difference between the purchase date and the production date of the product is less than eighteen months. Any product which has been warehoused for more than this period will only be covered by Fulgor Milano's B-Stock warranty.

During the warranty period Fulgor Milano reserves the right to evaluate the opportunity to repair the appliance or, at their discretion, offer to replace it with a Fulgor Milano product of equivalent features and functionality but cannot guarantee that the exact model will still be available. Fulgor Milano reserves the right to revise these warranties at any time.

Some states do not allow the exclusion or limitation of incidental or consequential damages so the above limitation or exclusion may not apply to you. These warranties give you specific legal rights and you may also have other rights which vary from state to state.

*Replacement light bulbs / LEDs are only covered under the terms of the Class 0, 30 day cosmetic warranty.

TERMS AND CONDITIONS

Prices	Price lists are subject to change without notice. All shipments will be invoiced at prices prevailing at the time of order. This price list supersedes any and all previous price lists.
Terms	Net 30 days from shipment of product with approved credit.
Lead Times	Purchase orders for products that are in stock will ship within the next business day. Estimated lead times will be provided for all non-stock items.
Returns	Product being returned must have a Return Materials Authorization (RMA) and Dealer assumes responsibility for all freight cost. Your Regional Account Manager or Service Department must generate RMA's. Any product returned without an RMA will be refused and returned to the sender. RMA's are valid for (30) days.
Restocking	Unopened merchandise being accepted for return will be subject to a 25% restocking charge and Dealer assumes responsibility for all freight cost. The merchandise must be properly packaged and in brand new sellable condition. All products received in less than 100% sellable condition will be refused and sent back to the dealer. No credit will be issued on any returned merchandise that is not in 100% sellable condition.
Damage Claims	All Fulgor Milano items must be inspected at the time of delivery. Damages MUST be refused and Maple Distributing should be notified. Once the units are received in good condition, Maple Distributing will not be responsible for any damaged product.

WAREHOUSE:

2100 Century Cir.
Irving, TX 75062

WAREHOUSE HOURS:
M-F 8AM-4PM CST

SERVICE DEPT: (800) 866-4774
support@mapledistributing.com



ORDER DEPT:

(800) 866-4774
FAX: (214) 352-0348

OFFICE HOURS:
M-F 8AM-5PM CST



Maple Distributing, LLC
Phone: 800-866-4774 Fax: 214-352-0348
orders@mapledistributing.com
www.mapledistributing.com