

# falmec

## 2022 Falmec Retail Price book



### Falmec Retail Price Book

Effective February 1, 2022

800-866-4774

[www.mapledistributing.com](http://www.mapledistributing.com)

[orders@mapledistributing.com](mailto:orders@mapledistributing.com)



## Innovation In The Air

Founded in 1981, **Falmec** has evolved from a small manufacturing company to a leading force both in the national and international market, gaining extensive experience in the design and production of ventilation hoods.

Cutting-edge research, flexibility in production, development of new technologies and original creativity provide the Falmec collection with strong added value in innovation, and a totally unique blend of design and technology, reaching the highest level of Italian excellence in the world.

All Falmec creations are the result of a complex, multi-phase process that is entirely designed, planned and produced in Vittorio Veneto, located in Northeast Italy.



## Made In Italy

From initial design to finished product, all of Falmec's creations are achieved through a multi-step process that is run entirely onsite at the company headquarters, located near Venice. Falmec's products offer an absolute guarantee of quality in the design, the materials and the construction, in the best Italian manufacturing tradition.



## Quality

Each Falmec product is the result of careful research, meticulous testing and extreme precision in their construction. Falmec's facilities rely on state of the art technology and are equipped with numerous robotic lines that enable them to meet top quality standards.



## Technology & Quality

**Innovation. Performance. Energy Efficiency. Ease of Installation. Design**

These are the key concepts of all Falmec projects. They are the outcome of ongoing research that considers aesthetics, materials and technologies as a single set in order to achieve the perfect synergy.

Falmec's products satisfy every sense: smell, for the effectiveness of air movement; sight and touch, thanks to the refined design and the quality of materials; hearing, for their extremely silent performance.

## Select Stainless Steel

### Stainless Steel AISI 304

Falmec selects and uses AISI Stainless steel AISI 304, with an alloy containing 18% chromium and 8% nickel. Hygienic, easy to clean, highly resistant to corrosion, as demonstrated by salt spray tests, AISI 304 is by far the best material for the production of ventilation hoods.



## WHAT IS NRS TECHNOLOGY? THE DIFFERENCE IS EXPERIENCED, NOT HEARD



NRS (Noise Reduction System) is the exclusive system developed by Falmec in collaboration with laboratories specializing in fluid dynamics. It has enabled us to create a collection of incredibly quiet hoods, with considerable improvements in quality of life in the kitchen. NRS technology allows you to cook, work, chat and listen to music without the noise typically produced by hoods, while maintaining excellent extraction performance.

### UP TO 86% LESS NOISE

Thanks to research into airflow and the specialist materials used, NRS hoods reduce noise to an extremely low, almost imperceptible level. The NRS system gives the best results through the evacuation of cooking fumes, but can also be used in recirculation mode with a long-lasting, regenerable high-performance filter.

### NRS

	1	2	3	4
NRS	37	41	46	54
STANDARD HOOD	49	56	62	68

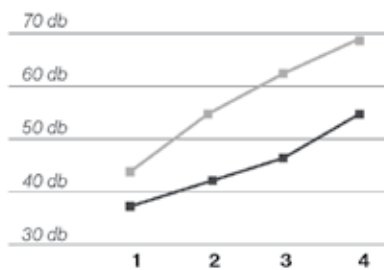

*\* Data referring to an Plane NRS model, tested at maximum power*

Diagram of internal flows in an NRS hood. Soundproofing the Blower chamber and research into airflows reduces operating noise to a minimum.

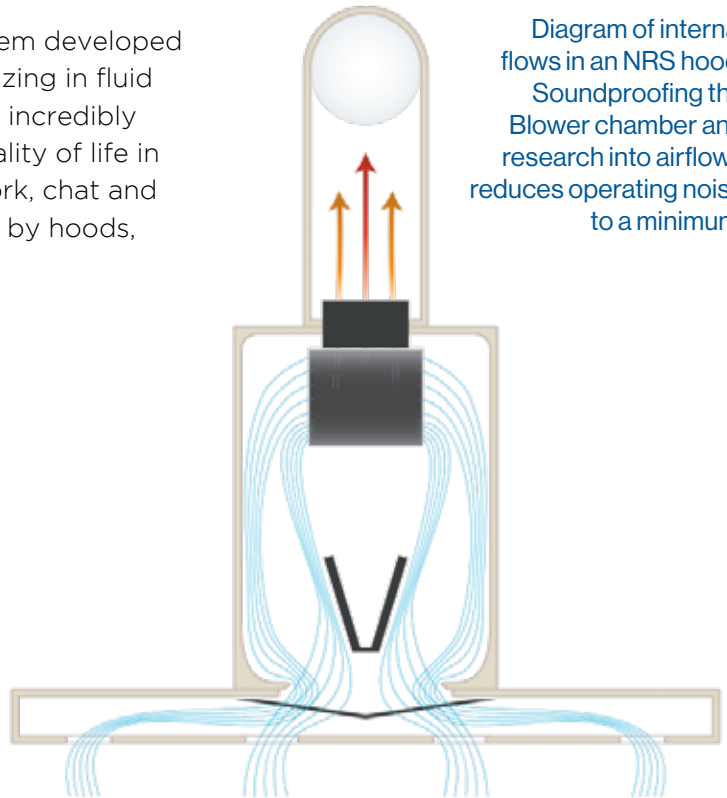

Find out more about our Silence - NRS Technology



## Speed Reduction System (SRS)



The Falmec SRS is available on select hoods and allows installers to permanently set the maximum CFM of the hood to meet local building codes. The SRS can be adjusted in 3 easy steps.

Motor	Speed			
	1	2	3	4*
500 CFM (800 m <sup>3</sup> /h)	120 CFM	200 CFM	290 CFM	500 CFM
600 CFM (1000 m <sup>3</sup> /h)	150 CFM	290 CFM	390 CFM	600 CFM

\* Factory standard setting is set to level 4



### Setting Max Speed to Setting 3 (290 or 390 CFM)



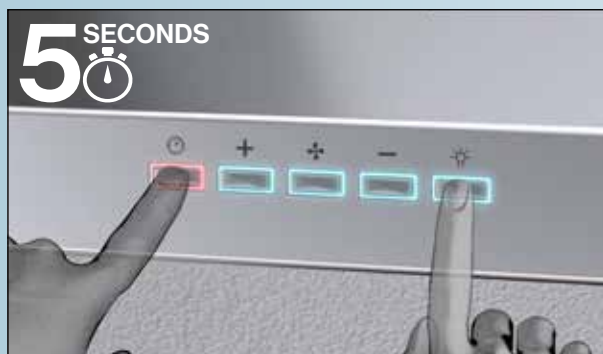





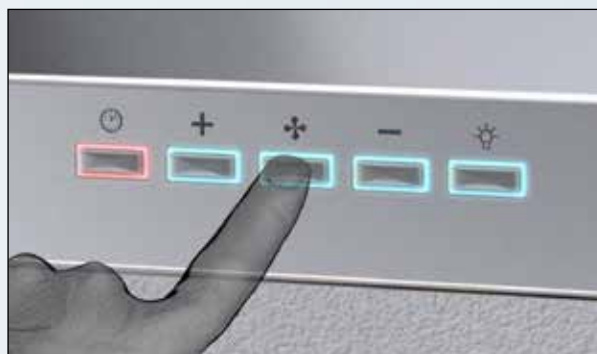
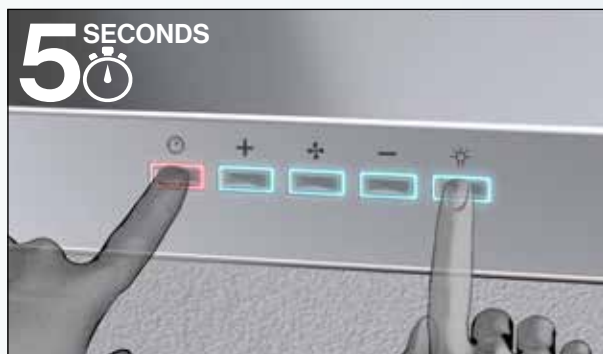































1. To enter the setup mode, press and hold the two outer buttons for 5 seconds until all the lights flash.
2. Press the plus (+) button to set the blower's max speed to level 3.
3. Setting complete



### Setting Max Speed to Setting 2 (200 or 290 CFM)

1. To enter the setup mode, press and hold the two outer buttons for 5 seconds until all the lights flash.
2. Press the fan (⊕) button to set the blower's max speed to level 2.
3. Setting complete



WALL		ISLAND		BUILT-IN	
 Pyramid Pro p. 11	 Lumen p. 40	 Pyramid Pro p. 11	 Massimo Pro NRS p. 17	 Virgola p. 26	
 Pyramid Pro NRS p. 12	 Prestige p. 42	 Plane NRS p. 32	 Vittorio Pro p. 19	 Move p. 27	
 Zeus Pro NRS p. 13	 Rialto Top p. 43	 Lumina NRS p. 33	 Massimo Pro p. 20	 Sabina p. 28	
 Zeus Pro p. 14	 Mira Top p. 44	 Polar p. 34	 Danilo p. 22	 Mara p. 29	
 Line Pro NRS p. 16	 Verso NRS p. 45	 Plane Top p. 35	 Incasso NRS p. 23	 Eros p. 52	
 Prisma p. 31	 Vulcano p. 49	 Lumen p. 40	 Valentina p. 24	 Boreas p. 54	
 Plane NRS p. 32	 Mercurio p. 50	 Lumen Island 175 p. 41	 Valentina Black/White p. 25	 Mercurio p. 55	
 Lumina NRS p. 33	 Afrodite p. 51	 Mira p. 43			
 Plane Top p. 35		 Mercurio p. 50			

### WORKTOP



Down Draft  
p. 46

### CEILING



Nuvola Led 90  
p. 36



Stella  
p. 38



Nuvola Led 140  
p. 37



Nube  
p. 39

### OUTDOOR



Zeus Outdoor  
p. 57



Pyramid  
Outdoor  
p. 59



Line Outdoor  
p. 58



# TABLE OF CONTENTS

	Page
<b>ABOUT FALMEC</b>	<b>2</b>
<b>NRS &amp; SRS TECHNOLOGY</b>	<b>6</b>
Picture Index	8
Professional Collection	10
Built-In Collection	18
Design Collection	30
Potenza Collection	48
Outdoor Collection	56
Accessories	60
<b>FALMEC LIMITED WARRANTY</b>	<b>66</b>
<b>Notes</b>	<b>67</b>



# PROFESSIONAL COLLECTION

## Pyramid Pro

### FEATURES

- Wall or Island Mounted Models
- 304 Stainless Steel
- 3 Speed Motor
- LED Lighting
- Professional Baffle Filters
- Professional Knob Controls



MODEL	CFM	WIDTH	DUCT SIZE
FPDPR30W6SS-3	600	30" - Wall	6"
FPDPR36W9SS-3	1000	36" - Wall	8"
FPDPR48W9SS-3	1000	48" - Wall	8"
FPDPR36I9SS-3	1000	36" - Island	8"

### DUCT COVERS

MODEL	DESCRIPTION	CEILING HEIGHT
KCPHN.00#3	60" Duct Cover Extension (For Wall Mount Hoods)	12"

### ACCESSORIES

MODEL	DESCRIPTION
KACL.815	Protective Cleaning Cloths for Stainless Steel (Box 10 Pcs)
101080195	Baffle Filter - 22" Deep
101080200	Standard Baffle Recirculation Filter - Island

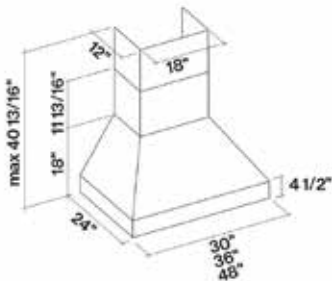

Wall Mount

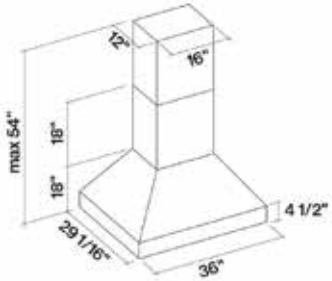

Island Mount

## Pyramid Pro NRS



### Features

- Wall Mounted
- Noise Reduction System for Quiet Operation
- 304 Stainless Steel
- LED Lighting
- Professional Baffle Filters
- Touch Control 4 Speed Motor
- Delayed Shut Off Option
- Clean Filter Reminder
- Optional Carbon.Zeo Filter Kit



MODEL	CFM	WIDTH	DUCT SIZE	MAP	MSRP
FNPYR30W6SS	600	30"	6"	\$ 2,149	\$ 2,259
FNPYR36W6SS	600	36"	6"	\$ 2,259	\$ 2,379

### DUCT COVERS

MODEL	DESCRIPTION	CEILING HEIGHT	MAP	MSRP
KCPHN.00#3	60" Duct Cover Extension (For Wall Mount Hoods)	12'	\$ 279	\$ 319

### ACCESSORIES

MODEL	DESCRIPTION	MAP	MSRP
KACL.815	Protective Cleaning Cloths for Stainless Steel (Box 10 Pcs)	\$ 29	\$ 34
101080195	Baffle Filter - 22" Deep - Wall Mount	\$ 99	\$ 119
101080200	Standard Baffle Recirculation Filter - Island Mount	\$ 79	\$ 99
KACL.948#IF	Carbon.Zeo Filtering Kit	\$ 399	\$ 439
KACL.953#BF	Carbon.Zeo Filter Kit (Vertical Ceiling)	\$ 789	\$ 849

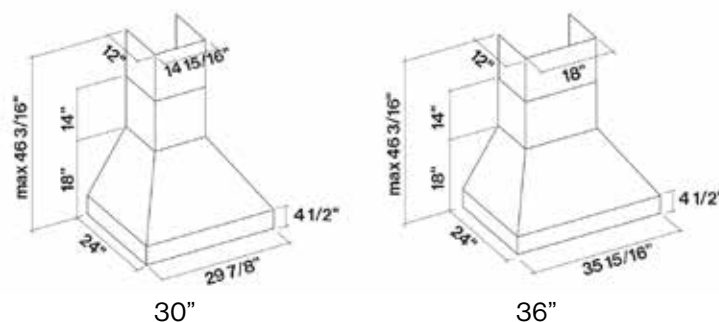



## Zeus Pro NRS



### FEATURES

- Wall Mounted
- Noise Reduction System for Quiet Operation
- 304 Stainless Steel
- LED Lighting
- Professional Baffle Filters
- Touch Control 4 Speed Motor
- Delayed Shut Off Option
- Clean Filter Reminder
- Optional Carbon.Zeo Filter Kit

*\*Not available in Back Vent Application\**

MODEL	CFM	WIDTH	DUCT SIZE	MAP	MSRP
FNZEU30W6SS	600	30"	6"	\$ 2,149	\$ 2,259
FNZEU36W6SS	600	36"	6"	\$ 2,249	\$ 2,369

### DUCT COVERS

MODEL	DESCRIPTION	CEILING HEIGHT	WIDTH	MAP	MSRP
KACL.570#I	28" Duct Cover Extension	9.5'	30"	\$ 239	\$ 279
KACL.571#I	28" Duct Cover Extension	9.5'	36"	\$ 239	\$ 279

### ACCESSORIES

MODEL	DESCRIPTION	MAP	MSRP
KACL.815	Protective Cleaning Cloths for Stainless Steel (Box 10 Pcs)	\$ 29	\$ 34
KACL.948#IF	Carbon.Zeo Filtering Kit	\$ 399	\$ 439

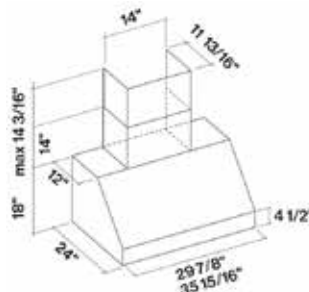

Optional Duct Cover Shown



## Zeus Pro

### FEATURES

- Wall Mounted
- 304 Stainless Steel
- 3 Speed Motor
- LED Lighting
- Professional Baffle Filters
- Professional Knob Control

*\*Not available in Back Vent Application\**

MODEL	CFM	WIDTH	DUCT SIZE	MAP	MSRP
FP18P30W6SS-3	600	30"	6"	\$ 1,129	\$ 1,189
FP18P36W6SS-3	600	36"	6"	\$ 1,179	\$ 1,239
FP18P36W9SS-3	1000	36"	8"	\$ 1,399	\$ 1,469
FP18P48W9SS-3	1000	48"	8"	\$ 1,649	\$ 1,739

## DUCT COVERS

MODEL	DESCRIPTION	CEILING HEIGHT	WIDTH	MAP	MSRP
KCPHN.004#3F	30" Duct Cover Extension	9.5' - 10'	30"	\$ 239	\$ 259
KCPHN.005#3F	30" Duct Cover Extension	9.5' - 10'	36"	\$ 269	\$ 289
KCPHN.006#3F	30" Duct Cover Extension	9.5' - 10'	48"	\$ 299	\$ 319

## ACCESSORIES

MODEL	DESCRIPTION	MAP	MSRP
KACL.815	Protective Cleaning Cloths for Stainless Steel (Box 10 Pcs)	\$ 29	\$ 34
101080195	Baffle Filter - 22" Deep	\$ 99	\$ 119

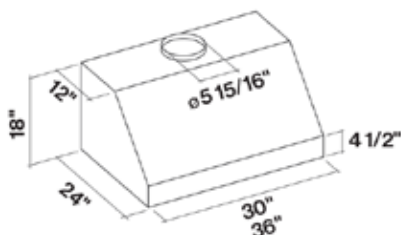

600 CFM

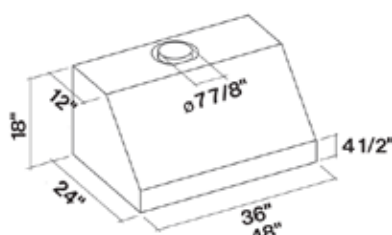

1000 CFM

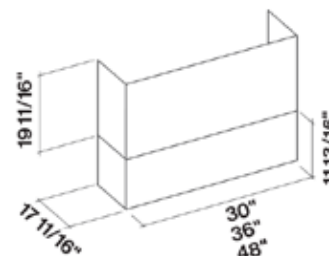

Optional Duct Cover





## Line Pro NRS



### Features

- Wall Mounted
- Noise Reduction System for Quiet Operation
- 304 Stainless Steel
- LED Lighting
- Professional Baffle Filters
- Touch Control 4 Speed Motor
- Delayed Shut Off Option
- Clean Filter Reminder
- Optional Carbon.Zeo Filter Kit

MODEL	CFM	WIDTH	DUCT SIZE	MAP	MSRP
FNLIN30W6SS	600	30"	6"	\$ 1,849	\$ 1,949
FNLIN36W6SS	600	36"	6"	\$ 1,899	\$ 1,999

## DUCT COVERS

MODEL	DESCRIPTION	CEILING HEIGHT	WIDTH	MAP	MSRP
KACL.570#1	28" Duct Cover Extension	11.5'	30"	\$ 239	\$ 279
KACL.571#1	28" Duct Cover Extension	11.5'	36"	\$ 239	\$ 279

## ACCESSORIES

MODEL	DESCRIPTION	MAP	MSRP
KACL.815	Protective Cleaning Cloths for Stainless Steel (Box 10 Pcs)	\$ 29	\$ 34
101080195	Baffle Filter - 22" Deep	\$ 99	\$ 119
KACL.948#IF	Carbon.Zeo Filtering Kit	\$ 399	\$ 439
KACL.953#BF	Carbon.Zeo Filter Kit (Vertical Ceiling)	\$ 789	\$ 849
KACL.961	Charcoal Filter	\$ 109	\$ 129

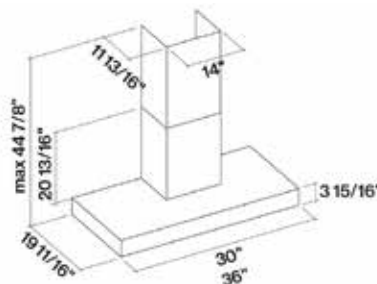

Wall Mount



## Massimo Pro NRS



### Features

- Built-In
- Noise Reduction System for Quiet Operation
- 304 Stainless Steel
- 4 Speed Electronic Touch Control
- LED Lighting
- Professional Baffle Filters
- Delayed Shut Off Option
- Clean Filter Reminder
- Optional Carbon.Zeo Filter Kit



MODEL	COLOR	CFM	WIDTH	DUCT SIZE	MAP	MSRP
FNMAS30W6SS	SS	600	28"	6"	\$ 1,649	\$ 1,739
FNMAS36W6SS	SS	600	34"	6"	\$ 1,699	\$ 1,789

## ACCESSORIES

MODEL	DESCRIPTION	MAP	MSRP
KACL.815	Protective Cleaning Cloths for Stainless Steel (Box 10 Pcs)	\$ 29	\$ 34
KACL.961	Carbon.Zeo Filter Kit	\$ 109	\$ 129

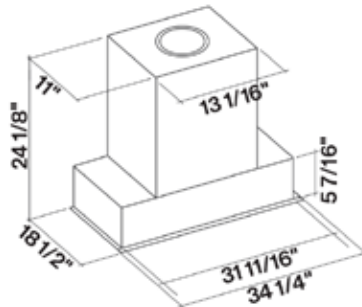
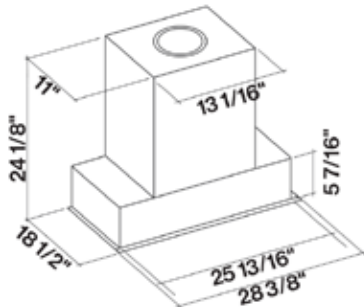

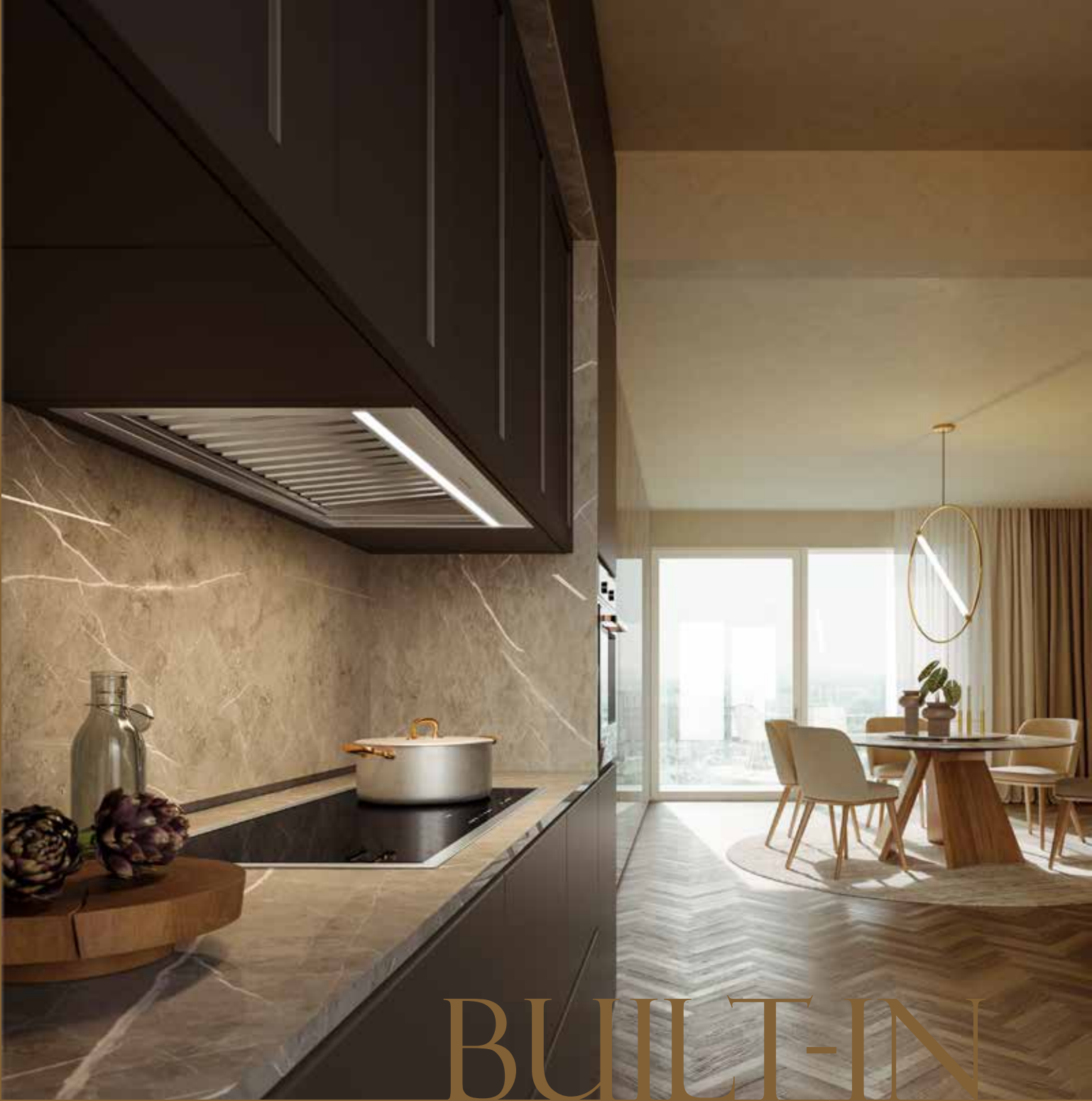

BUILT-IN  
COLLECTION

**NEW**



## Vittorio Pro

### Features

- Built-In
- Speed Reduction System
- 304 Stainless Steel
- Electronic Controls
- Dynamic LED Lighting (2700k - 5600k)
- Professional Baffle Filters
- Flush Installation
- Quick Fit Installation
- Remote Control Included

MODEL	COLOR	CFM	WIDTH	DUCT SIZE	MAP	MSRP
<b>NEW</b> FIVIT34B6SS	SS	600	34"	6"	\$ 1,199	\$ 1,259

### ACCESSORIES

MODEL	DESCRIPTION	MAP	MSRP
KACL.815	Protective Cleaning Cloths for Stainless Steel (Box 10 Pcs)	\$ 29	\$ 34
FFCHAR3COBL	Carbon Filter Kit	\$ 29	\$ 39

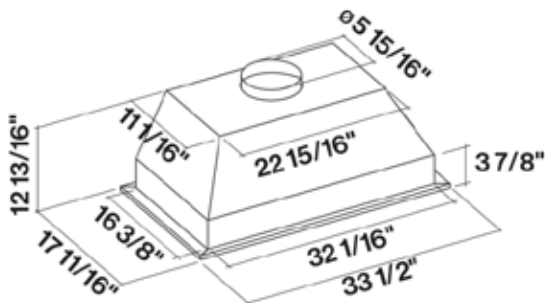

## Massimo Pro

Previously LINER36 & LINER48

### Features

- Built-In
- 304 Stainless Steel
- 3 Speed Motor
- LED Lighting
- Professional Baffle Filters
- Professional Knob Controls
- 18" and 22" Deep Models

\* Transition required to go from 2x6" round duct to 1x8" round duct is included with dual motor unit.



MODEL	CFM	WIDTH	DEPTH	DUCT SIZE	MAP	MSRP
FIMAS34B6SS-3	600	34"	18"	6"	\$ 799	\$ 839
FIMAX34B6SS-3	600	34"	22"	6"	\$ 869	\$ 919
FIMAS34B9SS-3*	1000	34"	18"	8"	\$ 1,189	\$ 1,249
FIMAX34B9SS-3*	1000	34"	22"	8"	\$ 1,199	\$ 1,259
FIMAS46B9SS-3*	1000	46"	18"	8"	\$ 1,299	\$ 1,369
FIMAX46B9SS-3*	1000	46"	22"	8"	\$ 1,349	\$ 1,419

## ACCESSORIES

MODEL	DESCRIPTION	MAP	MSRP
KACL.815	Protective Cleaning Cloths for Stainless Steel (Box 10 Pcs)	\$ 29	\$ 34
101080196	Baffle Filter - 18" Deep	\$ 99	\$ 109
101080195	Baffle Filter - 22" Deep	\$ 99	\$ 119
FFCHAR3COBL	Carbon Filter Kit - Order Qty 2 for FIMAS34B9SS-3, FIMAS46B9SS-3, or FIMAX46B9SS-3	\$ 29	\$ 39

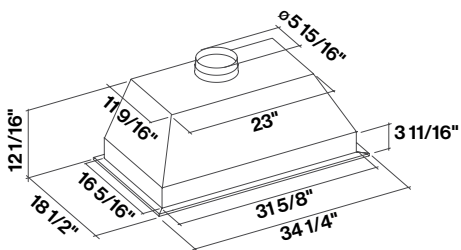

34" x 18" Depth Single Blower

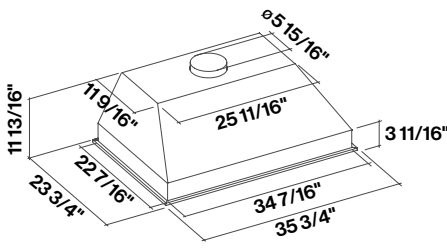

34" x 22" Depth Single Blower

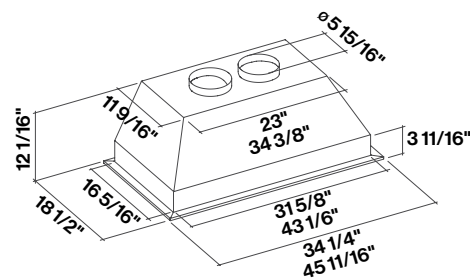

34"/46" x 18" Depth Dual Blower

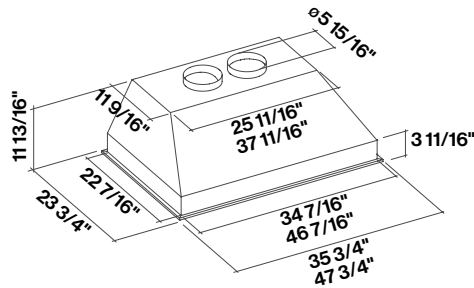

34"/46" x 22" Depth Dual Blower

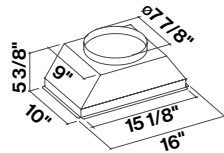

\* Transition required to go from 2x6" round duct to 1x8" round duct is included with all dual Blower units in this series.

## Danilo

### Features

- Built-In
- 304 Stainless Steel
- Professional Knob Control
- LED Lighting
- Professional Baffle Filter
- Optional Charcoal Filter



MODEL	COLOR	CFM	WIDTH	DUCT SIZE	MAP	MSRP
FIDAN28B6SS-3	SS	600	28"	6"	\$ 729	\$ 769

## ACCESSORIES

MODEL	DESCRIPTION	MAP	MSRP
KACL.815	Protective Cleaning Cloths for Stainless Steel (Box 10 Pcs)	\$ 29	\$ 34
101080197	Standard Baffle Filter	\$ 79	\$ 99
FFCHAR3COBL	Carbon Filter Kit	\$ 29	\$ 39

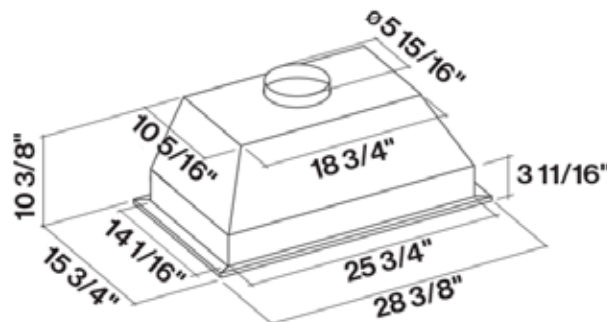



## Incasso NRS



### Features

- Built-In
- Noise Reduction System for Quiet Operation
- Speed Reduction System (28" Model)
- 304 Stainless Steel
- 4 Speed Electronic Control
- LED lighting
- Metallic Filters are Removable and Washable
- Remote Control Included
- Delayed Shut-Off Option
- Optional Carbon.Zeo Filter Kit

MODEL	COLOR	CFM	WIDTH	DUCT SIZE	MAP	MSRP
FNINS20B5SS-R	SS	500	20"	6"	\$ 1,599	\$ 1,679
FNINS28B5SS-R	SS	500	28"	6"	\$ 1,699	\$ 1,789

## ACCESSORIES

MODEL	DESCRIPTION	MAP	MSRP
KACL.845#I	28" Metallic Filter	\$ 69	\$ 79
KACL.844#I	20" Metallic Filter	\$ 89	\$ 109
KACL.815	Protective Cleaning Cloths for Stainless Steel (Box 10 Pcs)	\$ 29	\$ 34
KACL.961	Carbon.Zeo Filter Kit	\$ 109	\$ 129
105080053	Optional Remote Control	\$ 109	\$ 129

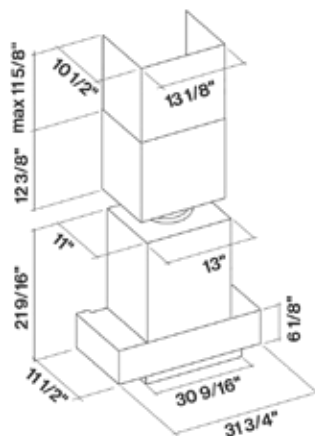

Remote Control

## Valentina

### Features

- Built-In
- Speed Reduction System
- 304 Stainless Steel
- 4 Speed Electronic Control
- LED Lighting
- Perimeter Suction
- Metallic Filters are Removable and Washable
- Optional Charcoal Filter
- Delayed Shut Off Option
- Optional Remote Control



MODEL	COLOR	CFM	WIDTH	DUCT SIZE	MAP	MSRP
FIVAL28B5SS-R	SS	500/390/285	28"	6"	\$ 829	\$ 879
FIVAL34B5SS-R	SS	500/390/285	34"	6"	\$ 929	\$ 979

## ACCESSORIES

MODEL	DESCRIPTION	MAP	MSRP
KACL.815	Protective Cleaning Cloths for Stainless Steel (Box 10 Pcs)	\$ 29	\$ 34
101080141	34" Metallic Filter	\$ 19	\$ 29
101080140	28" Metallic Filter	\$ 29	\$ 39
FFCHAR3COBL	Round Charcoal Filter	\$ 29	\$ 39
105080053	Optional Remote Control	\$ 109	\$ 129

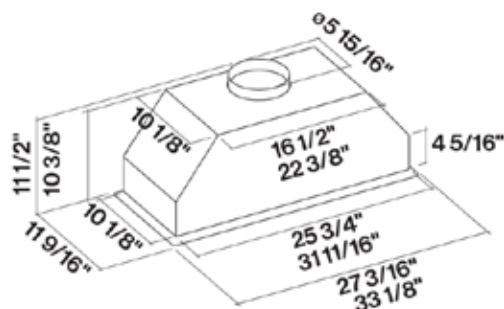

Remote Control





**NEW**

## Valentina Black/White



### Features

- Built-In
- Speed Reduction System
- Painted Stainless Steel
- Black or White Glass Panel
- Electronic Controls
- LED Lighting
- Perimeter Suction
- Flush Finish
- Quick Fit Installation
- Optional Carbon.Zeo Filter Kit
- Remote Control Option

	MODEL	COLOR	CFM	WIDTH	DUCT SIZE	MAP	MSRP
<b>NEW</b>	FIBUR28B5WH-R	White Glass	500	28"	6"	\$ 849	\$ 899
<b>NEW</b>	FIBUR28B5BK-R	Black Glass	500	28"	6"	\$ 849	\$ 899

## ACCESSORIES

MODEL	DESCRIPTION	MAP	MSRP
FFCHAR3COBL	Carbon Filter Kit	\$ 29	\$ 39
KACL.815	Protective Cleaning Cloths for Stainless Steel (Box 10 Pcs)	\$ 29	\$ 34
105080053	Optional Remote Control	\$ 109	\$ 129
KACL.950	Charcoal Zeo Lite Filter Unit	\$ 319	\$ 369
KACL.961	Carbon.Zeo Filter Kit	\$ 109	\$ 129

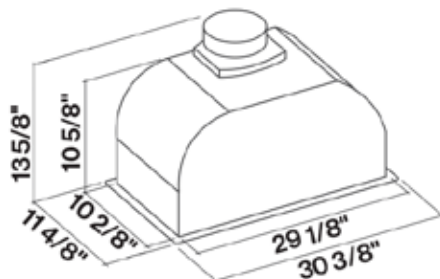

Optional Remote Control

## Virgola

### Features

- Built-In
- Noise Reduction System for Quiet Operation
- 304 Stainless Steel
- 3 Speed Electronic Control
- LED Lighting
- Metallic Filters are Removable and Washable
- Tempered Turning Glass
- Retractable Glass Visor
- Telescopic Duct Cover Included
- Optional Carbon.Zeo Filter System
- Optional Charcoal Filter



MODEL	COLOR	CFM	WIDTH	DUCT SIZE	MAP	MSRP
FDVRG24W5SS-R	SS	500	24"	6"	\$ 729	\$ 769
FDVRG36W5SS-R	SS	500	36"	6"	\$ 769	\$ 809

## ACCESSORIES

MODEL	DESCRIPTION	MAP	MSRP
KACL.815	Protective Cleaning Cloths for Stainless Steel (Box 10 Pcs)	\$ 29	\$ 34
KCVJN.00#3	Optional Telescopic Chimney (Height - 7 1/4")	\$ 49	\$ 59
101079910	36" Metallic Filter	\$ 29	\$ 34
FFCHASQC0BL	Square Charcoal Filter	\$ 19	\$ 29
KACL.950	Carbon.Zeo Filter Kit	\$ 319	\$ 369
KACL.934	Carbon.Zeo Filter	\$ 139	\$ 159

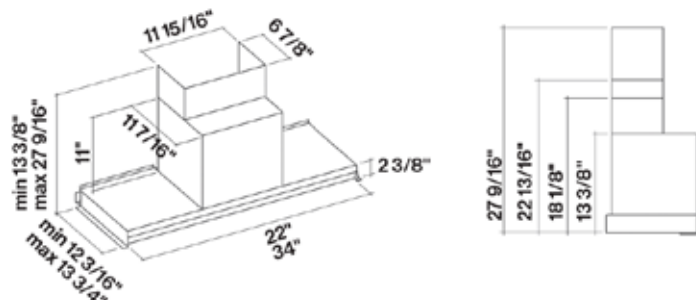



## Move

### Features

- Built-In
- 304 Stainless Steel
- 4 Speed Electronic Control
- LED Lighting
- Metallic Filters are Removable and Washable
- Lower Part is Black Tempered Glass
- Retractable Glass Visor
- Rear Vent Optional
- Optional Chimney
- Optional Glass Shelf
- Optional Carbon.Zeo Filter Kit

MODEL	COLOR	CFM	WIDTH	DUCT SIZE	MAP	MSRP
FDMOV36W5SB	Black	500	36"	6"	\$ 1,349	\$ 1,419

## ACCESSORIES

MODEL	DESCRIPTION	MAP	MSRP
KACL.815	Protective Cleaning Cloths for Stainless Steel (Box 10 Pcs)	\$ 29	\$ 34
KACL.107	Optional Glass Shelf 36"	\$ 159	\$ 179
KCVJN.00#3	Optional Telescopic Chimney (Height - 7 1/4")	\$ 49	\$ 59
KCVJN.01#3	Optional Chimney (Height - 4 3/4")	\$ 29	\$ 39
101080250	Metallic Filter	\$ 29	\$ 39
KACL.961	Carbon.Zeo Filter Kit	\$ 109	\$ 129

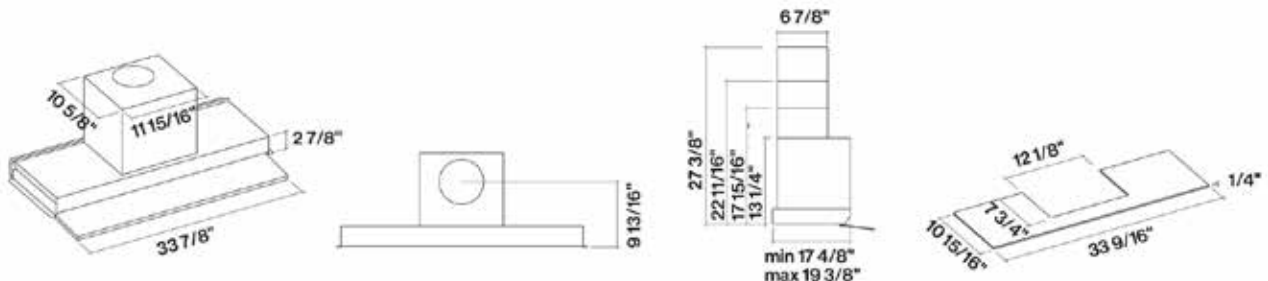

Optional Chimney

Optional Shelf

## Sabina

### Features

- Built-In
- 304 Stainless Steel
- 3 Speed Slider Control
- LED Lighting
- Metallic Filters are Removable and Washable
- Optional Charcoal Filter



MODEL	COLOR	CFM	WIDTH	DUCT SIZE	MAP	MSRP
FISAB22B3SS-1	SS	280	22"	6"	\$ 429	\$ 459
FISAB28B3SS-1	SS	280	28"	6"	\$ 449	\$ 479

## ACCESSORIES

MODEL	DESCRIPTION	MAP	MSRP
KACL.815	Protective Cleaning Cloths for Stainless Steel (Box 10 Pcs)	\$ 29	\$ 34
101080145	22" Metallic Filter	\$ 19	\$ 29
101080140	28" Metallic Filter	\$ 29	\$ 39
FFCHAR2COBL	Round Charcoal Filter	\$ 29	\$ 39

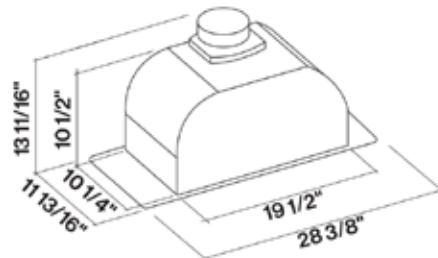
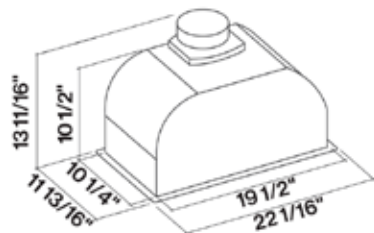



## Mara

### Features

- Built-In
- 304 Stainless Steel
- 3 Speed Slider Control
- LED Lighting
- Metallic Filters are Removable and Washable
- Recirculating Option

MODEL	COLOR	CFM	WIDTH	DUCT SIZE	MAP	MSRP
FIMAR22B6SS	SS	600	22"	6"	\$ 629	\$ 669
FIMAR28B6SS	SS	600	28"	6"	\$ 649	\$ 689

## ACCESSORIES

MODEL	DESCRIPTION	MAP	MSRP
KACL.815	Protective Cleaning Cloths for Stainless Steel (Box 10 Pcs)	\$ 29	\$ 34
101080138	22" Metallic Filter	\$ 29	\$ 39
101080139	28" Metallic Filter	\$ 29	\$ 39
FFCHAR3COBL	Carbon Filter Kit	\$ 29	\$ 29

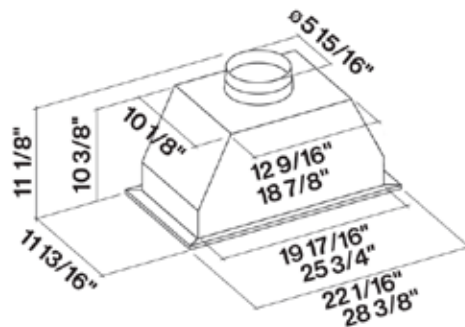

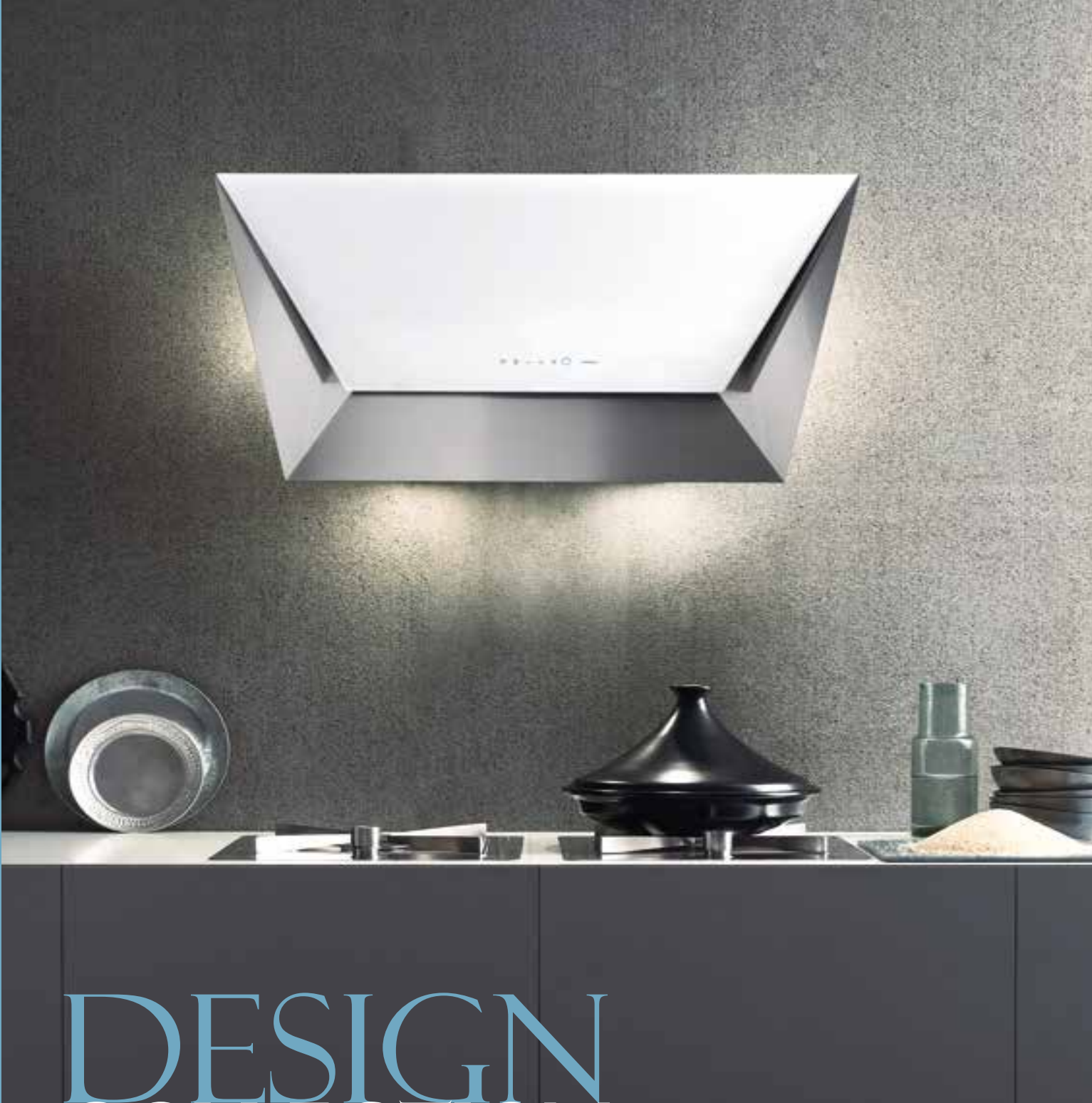

DESIGN  
COLLECTION



## Prisma

### Features

- Wall Mounted
- 304 Stainless Steel
- 4 Speed Electronic Touch Control
- LED Lighting / LED Ambient Lighting
- Charcoal Filter Included
- Top Filters are Removable & Washable
- Tempered White or Black Glass
- Perimeter Suction
- Delayed Shut Off Option
- Clean Filter Reminder
- Recirculating Option
- Optional Carbon.Zeo Filter Kit

MODEL	COLOR	CFM	WIDTH	DUCT SIZE	MAP	MSRP
FDPRI36W5SB	Black	500	36"	6"	\$ 1,649	\$ 1,739
FDPRI36W5SW	White	500	36"	6"	\$ 1,649	\$ 1,739

### DUCT COVERS

MODEL	DESCRIPTION	MAP	MSRP
KCQAN.00#I	Optional 30" Duct Cover (Stainless steel)	\$ 179	\$ 209

### ACCESSORIES

MODEL	DESCRIPTION	MAP	MSRP
KACL.815	Protective Cleaning Cloths for Stainless Steel (Box 10 Pcs)	\$ 29	\$ 34
KACL.941	Carbon.Zeo Filter	\$ 379	\$ 429
FFCHAR3COBL	Round Charcoal Filter	\$ 29	\$ 39
101080205	Metallic Filter	\$ 59	\$ 69

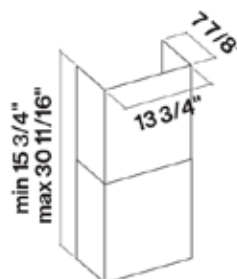
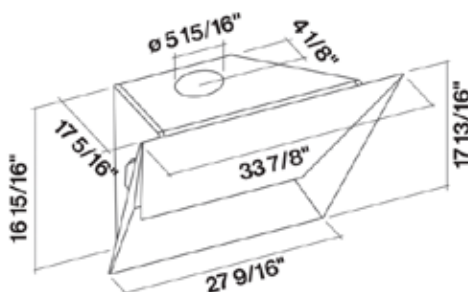

Optional Chimney

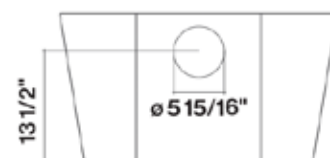

Rear View

## Plane NRS



### Features

- Wall or Island Mounted
- Noise Reduction System for Quiet Operation
- Speed Reduction System
- 304 Stainless Steel
- Electronic Control
- LED Lighting
- Removable and Washable Metallic Filters
- Delayed Shut Off Option
- Clean Filter Reminder
- Optional Charcoal Filter
- Optional Carbon.Zeo Filter Kit



MODEL	Color	CFM	WIDTH	DUCT SIZE	MAP	MSRP
FNPLS30W5SS-R	SS	500/390/285	30"-Wall	6"	\$ 1,599	\$ 1,679
FNPLS36W5SS-R	SS	500/390/285	36"-Wall	6"	\$ 1,649	\$ 1,739
FNPLS36I5SS-R	SS	500/390/285	36"- Island	6"	\$ 2,199	\$ 2,309
<b>NEW</b> FNPLS48W5SS-R	SS	500/390/285	48"-Wall	6"	\$ 1,849	\$ 1,949
<b>NEW</b> FNPLS48I5SS-R	SS	500/390/285	48"- Island	6"	\$ 2,269	\$ 2,389

### DUCT COVERS

MODEL	DESCRIPTION	CEILING HEIGHT	MAP	MSRP
KACL.570#I	27" Duct Cover Extension - Wall	11'	\$ 239	\$ 279
KACL.571#I	38" Duct Cover Extension - Wall	12'	\$ 239	\$ 279
KACL.572#I	48" Duct Cover Extension - Island	13'	\$ 589	\$ 669

### ACCESSORIES

MODEL	DESCRIPTION	MAP	MSRP
KACL.815	Protective Cleaning Cloths for Stainless Steel (Box 10 Pcs)	\$ 29	\$ 34
101080204	30" Metallic Filter	\$ 59	\$ 69
101078700	36" Metallic Filter	\$ 49	\$ 59
101078701	36" Metallic Filter Island	\$ 49	\$ 59
KACL.961	Carbon.Zeo Filter Kit	\$ 109	\$ 129

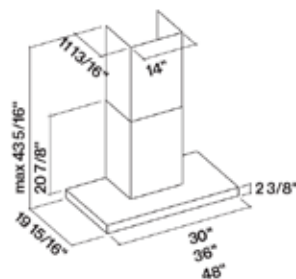

Wall Version

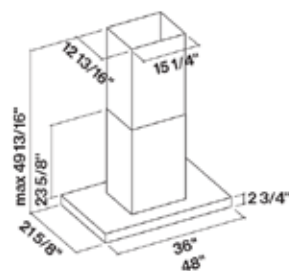

Island Version





**NEW**

## Lumina NRS



### Features

- Wall or Island Mounted
- Noise Reduction System for Quiet Operation
- 304 Stainless Steel
- 4 Speed Touch Control
- LED Lighting/LED Ambient Lighting
- Metallic Filters - Removable & Washable
- Tempered Glass with Stainless Steel
- Perimeter Suction
- Delayed Shut Off Function
- Clean Filter Reminder
- Optional Carbon.Zeo Filter Kit

MODEL	Color	CFM	WIDTH	DUCT SIZE	MAP	MSRP
FNLUM36W5SS	SS	500/390/285	36"-Wall	6"	\$ 1,999	\$ 2,099
FNLUM36I5SS	SS	500/390/285	36"-Island	6"	\$ 2,599	\$ 2,729

### DUCT COVERS

MODEL	DESCRIPTION	CEILING HEIGHT	MAP	MSRP
KACL.570#1	27" Duct Cover Extension - Wall	11'	\$ 239	\$ 279
KACL.571#1	38" Duct Cover Extension - Wall	12'	\$ 239	\$ 279
KACL.572#1	48" Duct Cover Extension - Island	13'	\$ 589	\$ 669

### ACCESSORIES

MODEL	DESCRIPTION	MAP	MSRP
KACL.815	Protective Cleaning Cloths for Stainless Steel (Box 10 Pcs)	\$ 29	\$ 34
101080240	Metallic Filter	\$ 39	\$ 44
KACL.961	Carbon.Zeo Filter Kit	\$ 109	\$ 129

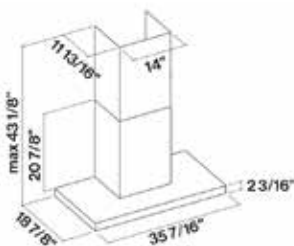

Wall Version

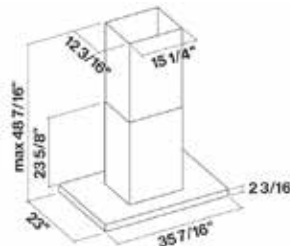

Island Version

## Polar

### Features

- Wall or Island Mounted
- Speed Reduction System
- 304 Stainless Steel
- Electronic Control
- LED Lighting
- Top Filters are Removable and Washable
- Delayed Shut Off Option
- Clean Filter Reminder



\* Shown with optional glass

MODEL	COLOR	CFM	WIDTH	DUCT SIZE	MAP	MSRP
FDPLR15W5SS-R	SS	500/390/285	15" - Wall	6"	\$ 1,559	\$ 1,639
FDPLR15I5SS-R	SS	500/390/285	15" - Island	6"	\$ 1,799	\$ 1,889

## ACCESSORIES

MODEL	DESCRIPTION	MAP	MSRP
KACL.815	Protective Cleaning Cloths for Stainless Steel (Box 10 Pcs)	\$ 29	\$ 34
FDPGL36W0TG	Optional Glass - Wall	\$ 249	\$ 269
FDPGL36I0TG	Optional Glass - Island	\$ 249	\$ 289
FFCHAR3COBL	Round Charcoal Filter	\$ 29	\$ 39
KACL.841#1	Metallic Filter	\$ 109	\$ 129

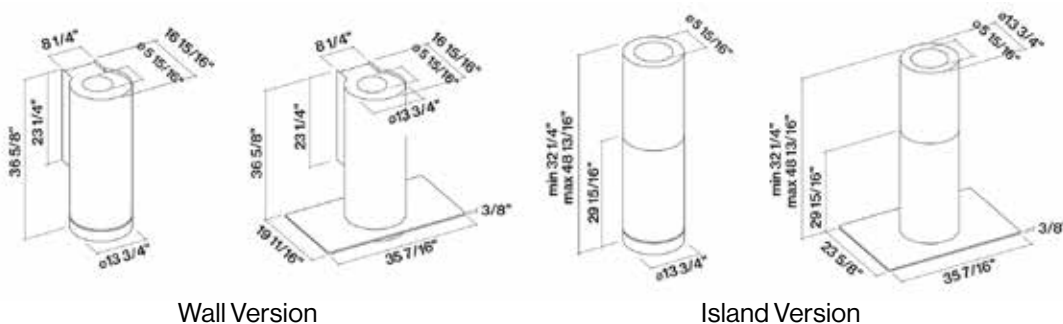



## Plane Top

### Features

- Wall or Island Mounted
- Speed Reduction System
- 304 Stainless Steel Fasteel Anti-Finger Print
- 4 Speed Electronic Control
- LED Lighting
- Metallic Filters are Removable and Washable
- Perimeter Suction
- Optional Charcoal Filter
- Recirculating Option
- Delayed Shut Off Option
- Clean Filter Reminder

MODEL	Color	CFM	WIDTH	DUCT SIZE	MAP	MSRP
FFPLN36W5FS-R	SS	500/390/285	36" - Wall	6"	\$ 1,299	\$ 1,369
FFPLN48W5FS-R	SS	500/390/285	48" - Wall	6"	\$ 1,499	\$ 1,579
FFPLN36I5FS-R	SS	500/390/285	36" - Island	6"	\$ 1,799	\$ 1,889

### DUCT COVERS

MODEL	DESCRIPTION	CEILING HEIGHT	MAP	MSRP
KACL.510#X	27" Duct Cover Extension - Wall	11'	\$ 199	\$ 229
KACL.512#X	38" Duct Cover Extension - Wall	12'	\$ 199	\$ 229
KACL.557#X	48" Duct Cover Extension - Island	13'	\$ 429	\$ 489

### ACCESSORIES

MODEL	DESCRIPTION	MAP	MSRP
KACL.815	Protective Cleaning Cloths for Stainless Steel (Box 10 Pcs)	\$ 29	\$ 34
101080240	Metallic Filter	\$ 39	\$ 44
FFCHASQC0BL	Square Charcoal Filter	\$ 19	\$ 29
KACL.948#IF	Carbon.Zeo Filter Kit	\$ 399	\$ 439

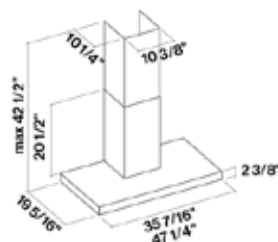

Wall Version

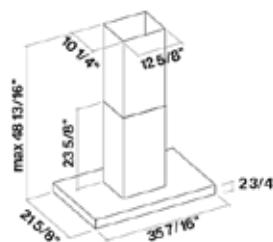

Island Version

WHITE VERSION AVAILABLE JULY 2022

**NEW**

## Nuvola 90

### Features

- Ceiling Mounted
- Speed Reduction System
- 304 Stainless Steel or Painted White
- Electronic Control
- LED Lighting
- Metallic Filter Removable and Washable
- Perimeter Suction
- Remote Control Included
- Delayed Shut Off Option
- Inline Blower Installation Available

*\*Motor Sold Separately*



MODEL	COLOR	CFM	WIDTH	DUCT SIZE	MAP	MSRP
FDNUV36C6SS-R1*	SS	Liner Only	36"	6"	\$ 1,629	\$ 1,719
<b>NEW</b> FDNUV36C6WH-R1*	White	Liner Only	36"	6"	\$ 1,669	\$ 1,759
FDNUMTR600*	SS	600/390/285	Motor Only	6"	\$ 449	\$ 479

*\*White Model Available in 2022*

## ACCESSORIES

MODEL	DESCRIPTION	MAP	MSRP
KACL.815	Protective Cleaning Cloths for Stainless Steel (Box 10 Pcs)	\$ 29	\$ 34
KACL.789	Side Junction for Ceiling	\$ 89	\$ 109
105080053	Remote Control Replacement	\$ 109	\$ 129
101080243	Metallic Filter	\$ 39	\$ 44
KACL.939#BF	Ceiling Recirculation Filter Pack	\$ 889	\$ 959
KACL.953#BF	Carbon.Zeo Filter Kit (Vertical Ceiling)	\$ 789	\$ 849

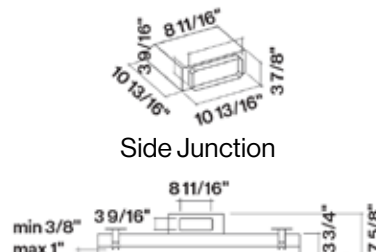
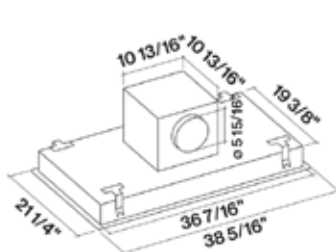

Side Junction



Remote Control

*Motor Sold Separately. Liner must be ordered with a motor.*



## Nuvola 140

### Features

- Ceiling Mounted
  - Speed Reduction System
  - 304 Stainless Steel
  - Electronic Control
  - LED Lighting
  - Metallic Filter Removable and Washable
  - Tempered Extra Light Painted Glass
  - Perimeter Suction
  - Remote Control Included
  - Delayed Shut Off Option
  - Inline Blower Installation Available
- \*Motor Sold Separately*

MODEL	COLOR	CFM	WIDTH	DUCT SIZE	MAP	MSRP
FDNUV54C6SS-R1*	SS	Liner Only	54"	6"	\$ 2,089	\$ 2,199
FDNUVMTR600*	SS	600/390/285	Motor Only	6"	\$ 449	\$ 479

### ACCESSORIES

MODEL	DESCRIPTION	MAP	MSRP
KACL.815	Protective Cleaning Cloths for Stainless Steel (Box 10 Pcs)	\$ 29	\$ 34
KACL.789	Side Junction for Ceiling	\$ 89	\$ 109
105080053	Remote Control Replacement	\$ 109	\$ 129
101080243	Metallic Filter	\$ 39	\$ 44
KACL.939#BF	Ceiling Recirculation Filter Pack	\$ 889	\$ 959
KACL.953#BF	Carbon.Zeo Filter Kit (Vertical Ceiling)	\$ 789	\$ 849

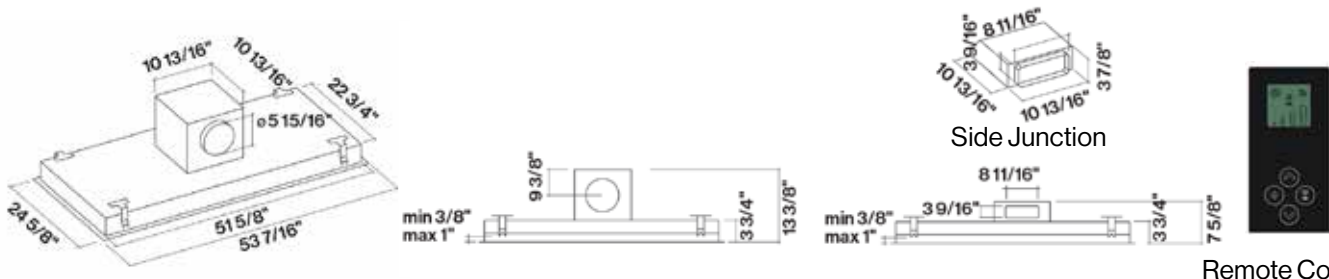

Remote Control

*Motor Sold Separately. Liner must be ordered with a motor.*

## Stella

### Features

- Ceiling Mounted
- Speed Reduction System
- 304 Stainless Steel
- 4 Speed Electronic Control
- Dynamic LED Lighting (2700k - 5600k)
- Metallic Filter is Removable and Washable
- Remote Control Included
- Perimeter Suction
- Delayed Shutoff Option
- Inline Blower Installation Available
- Motor Sold Separately



MODEL	COLOR	CFM	WIDTH	DUCT SIZE	MAP	MSRP
FDSTE36C6SS-R*	SS	Liner Only	36"	6"	\$ 1,599	\$ 1,679
FDSTE48C6SS-R*	SS	Liner Only	48"	6"	\$ 1,799	\$ 1,889
FDNUVMTR600*	SS	600/390/285	Motor Only	6"	\$ 449	\$ 479

## ACCESSORIES

MODEL	DESCRIPTION	MAP	MSRP
KACL.815	Protective Cleaning Cloths for Stainless Steel (Box 10 Pcs)	\$ 29	\$ 34
KACL.789	Side Junction for Ceiling	\$ 89	\$ 109
105080053	Remote Control Replacement	\$ 109	\$ 129
101080241	Metallic Filter	\$ 39	\$ 44
KACL.939#BF	Carbon Filter Kit (Ceiling)	\$ 889	\$ 959
KACL.953#BF	Carbon Filter Kit (Vertical Ceiling)	\$ 789	\$ 849

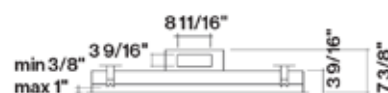
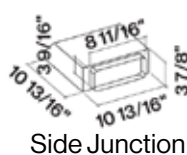
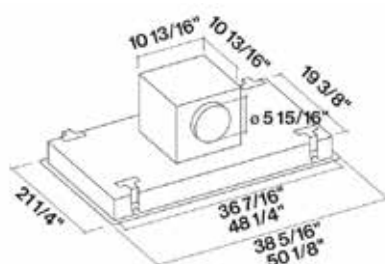

Remote Control

*Motor Sold Separately. Liner must be ordered with a motor.*

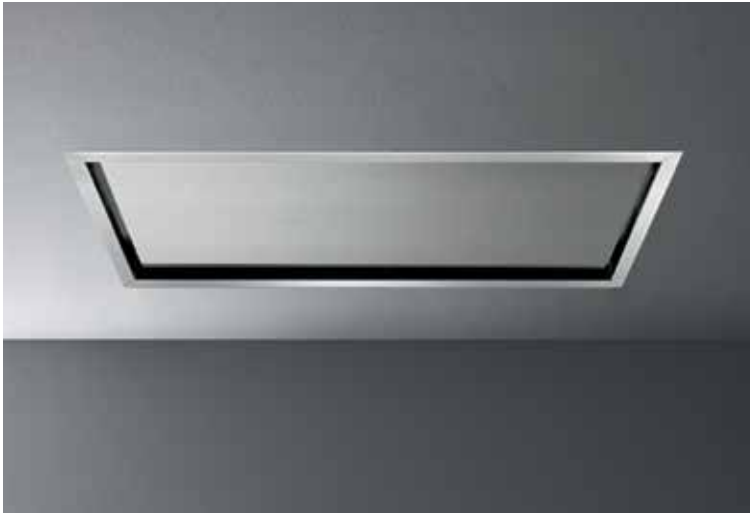

## Nube

### Features

- Ceiling Mounted
- Speed Reduction System
- 304 Stainless Steel
- 4 Speed Electronic Control
- Metallic Filter is Removable and Washable
- Remote Control Included
- Perimeter Suction
- Delayed Shut Off Option
- Inline Blower Installation Available
- Motor Sold Separately

MODEL	COLOR	CFM	WIDTH	DUCT SIZE	MAP	MSRP
FDNUB36C6SS*	SS	Liner Only	36"	6"	\$ 1,499	\$ 1,579
FDNUVMTR600*	SS	600	Motor Only	6"	\$ 449	\$ 479

## ACCESSORIES

MODEL	DESCRIPTION	MAP	MSRP
KACL.815	Protective Cleaning Cloths for Stainless Steel (Box 10 Pcs)	\$ 29	\$ 34
KACL.789	Side Junction for Ceiling	\$ 89	\$ 109
105080053	Remote Control Replacement	\$ 109	\$ 129
101080243	Metallic Filter	\$ 39	\$ 44
KACL.939#BF	Carbon.Zeo Filter Kit (Ceiling)	\$ 889	\$ 959
KACL.953#BF	Carbon.Zeo Filter Kit (Vertical Ceiling)	\$ 789	\$ 849
KACL.928	Spare Filters for KACL.939	\$ 179	\$ 209

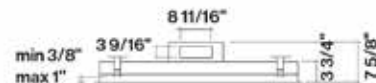
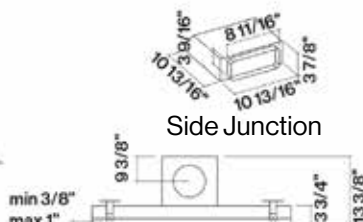
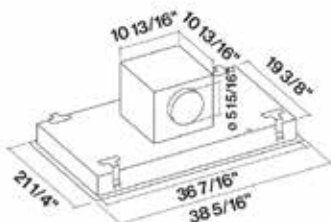

Remote Control

## Lumen

### Features

- Wall or Island Mounted
- Speed Reduction System
- 304 Stainless Steel
- Electronic Control
- LED Lighting/LED Ambient Light
- Air Falmec Filter
- Optional Remote Control
- Delayed Shut Off Option



MODEL	Color	CFM	WIDTH	DUCT SIZE	MAP	MSRP
FDLUM36W5SS-R	SS	500/390/285	36" - Wall	6"	\$ 1,199	\$ 1,259
FDLUM36I5SS-R	SS	500/390/285	36" - Island	6"	\$ 1,999	\$ 2,099

### DUCT COVERS

MODEL	DESCRIPTION	CEILING HEIGHT	MAP	MSRP
KACL.510#1	27" Duct Cover Extension - Wall	11'	\$ 189	\$ 209
KACL.512#1	38" Duct Cover Extension - Wall	12'	\$ 189	\$ 209
KACL.557#1	48" Duct Cover Extension - Island	13'	\$ 399	\$ 459

### ACCESSORIES

MODEL	DESCRIPTION	MAP	MSRP
KACL.815	Protective Cleaning Cloths for Stainless Steel (Box 10 Pcs)	\$ 29	\$ 34
101078702	Air Falmec Filter - 36" Wall	\$ 49	\$ 59
101078703	Air Falmec Filter - 36" Island	\$ 49	\$ 59
FFCHASQCOBL	Square Charcoal Filter	\$ 19	\$ 29
KACL.949#IF	Carbon.Zeo Filter Kit (Island Version)	\$ 529	\$ 569
KACL.948#IF	Carbon.Zeo Filter Kit (Wall Version)	\$ 399	\$ 439

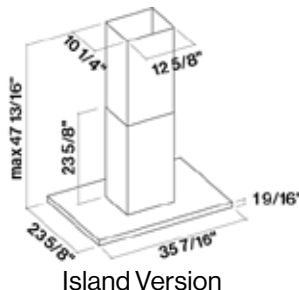
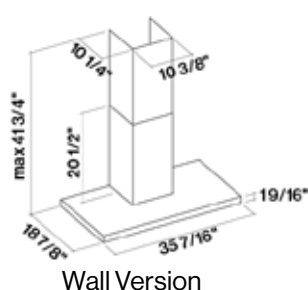

Remote Control





## Lumen Island 175

### Features

- Island Mounted
- Speed Reduction System
- 304 Stainless Steel
- Order as Left (L) or Right (R) Configuration
- 4 Speed Electronic Control
- LED Ambient Lighting on Both Sides
- Metallic Filters are Removable and Washable
- Perimeter Suction
- Recirculating Option
- Delayed Shut Off Option
- Remote Control Included

MODEL	Color	CFM	WIDTH	DUCT SIZE	MAP	MSRP
FDLUM70I5SS-2R	SS	500	70"	6"	\$ 2,699	\$ 2,839
FDLUM70I5SS-2L	SS	500	70"	6"	\$ 2,699	\$ 2,839

### DUCT COVERS

MODEL	DESCRIPTION	CEILING HEIGHT	MAP	MSRP
KACL.557#I	48" Duct Cover Extension - Island	13'	\$ 399	\$ 459

### ACCESSORIES

MODEL	DESCRIPTION	MAP	MSRP
KACL.815	Protective Cleaning Cloths for Stainless Steel (Box 10 Pcs)	\$ 29	\$ 34
KACL.350	Rod Extensions - 48"	\$ 129	\$ 149
101080240	Metallic Filter	\$ 39	\$ 44
FFCHASQCOBL	Square Charcoal Filter	\$ 19	\$ 29
KACL.949#IF	Carbon.Zeo Filter Kit	\$ 529	\$ 569

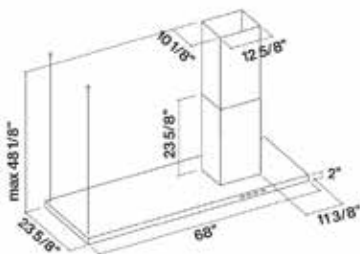

Right hand side example: chimney and button boards are on the right side when standing in front of the hood.



Remote Control



## Prestige

### Features

- Wall Mounted
- 304 Stainless Steel
- Tempered White or Black Glass
- Electronic Control Motor
- LED Lighting/LED Ambient Lighting
- Metallic Filters
- Top Filters are Removable and Washable
- Delayed Shut Off Option
- Clean Filter Reminder
- Optional Charcoal Filter

MODEL	COLOR	CFM	WIDTH	DUCT SIZE	MAP	MSRP
FDPST26W5SG	Black	500	26"	6"	\$ 2,789	\$ 2,929

## ACCESSORIES

MODEL	DESCRIPTION	MAP	MSRP
KACL.815	Protective Cleaning Cloths for Stainless Steel (Box 10 Pcs)	\$ 29	\$ 34
FFCHAR3COBL	Round Charcoal Filter	\$ 29	\$ 39
101080095	Metallic Filter	\$ 39	\$ 44

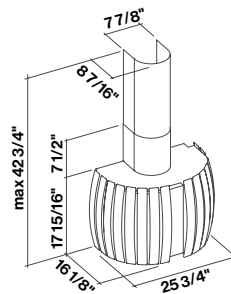

Wall Version

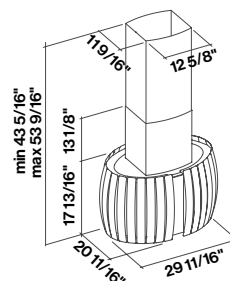

Island Version

## Rialto Top

### Features

- Wall Mounted
- 304 Stainless Steel Fasteel Anti-Finger Print
- 4 Speed Electronic Control
- LED Lighting/LED Ambient Light
- Top Filter is Removable and Washable
- Recirculating Option
- Delayed Shut Off Option
- Clean Filter Reminder



MODEL	COLOR	CFM	WIDTH	DUCT SIZE	MAP	MSRP
FFRIA24W5FS	SS	500	24"	6"	\$ 2,249	\$ 2,369

### ACCESSORIES

MODEL	DESCRIPTION	MAP	MSRP
KACL.815	Protective Cleaning Cloths for Stainless Steel (Box 10 Pcs)	\$ 29	\$ 34
101080097	Metallic Filter - Small Single	\$ 29	\$ 39
101080202	Metallic Filter - Large Two Piece	\$ 39	\$ 49
FFCHAR3COBL	Round Charcoal Filter	\$ 29	\$ 39

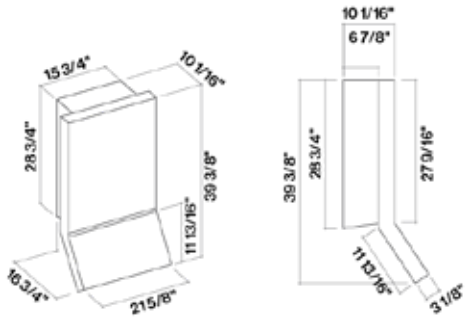

## Mira Top



### Features

- Wall or Island Mounted
- Speed Reduction System
- 304 Fasteel Stainless Steel
- 4 Speed Electronic Control
- LED Lighting
- Metallic Filters are Removable and Washable
- Perimeter Suction
- Recirculating Option (Out the Top)
- Delayed Shut Off Option
- Clean Filter Reminder
- Optional Charcoal Filter



MODEL	COLOR	CFM	WIDTH	DUCT SIZE	MAP	MSRP
FFMIR16W5FS-R	SS	500/390/285	16" - Wall	6"	\$ 1,199	\$ 1,259
FFMIR16I5FS-R	SS	500/390/285	16" - Island	6"	\$ 1,499	\$ 1,579

## ACCESSORIES

MODEL	DESCRIPTION	MAP	MSRP
KACL.815	Protective Cleaning Cloths for Stainless Steel (Box 10 Pcs)	\$ 29	\$ 34
101079900	Metallic Filter (Wall)	\$ 19	\$ 29
101080244	Metallic Filter (Island)	\$ 39	\$ 44
FFCHASQCOBL	Square Charcoal Filter (Wall)	\$ 19	\$ 29
FFCHAR3COBL	Round Charcoal Filter (Island)	\$ 29	\$ 39

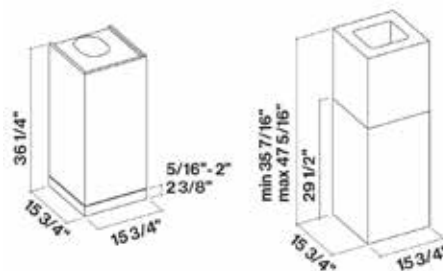

AVAILABLE JULY 2022

NEW

## Verso NRS



### Features

- Wall Mounted
- Noise Reduction System
- Black or White Tempered Glass
- Touch Control
- Dynamic LED Lighting (2700k - 5600k)
- Top Filter is Removable and Washable
- Charcoal Filter Included
- Delayed Shut Off Option
- Clean Filter Reminder

	MODEL	COLOR	CFM	WIDTH	DUCT SIZE	MAP	MSRP
NEW	FDVER36W5WH	White	500	36"	6"	\$ 1,799	\$ 1,889
NEW	FDVER36W5BK	Black	500	36"	6"	\$ 1,799	\$ 1,889

## ACCESSORIES

MODEL	DESCRIPTION	MAP	MSRP
KACL.815	Protective Cleaning Cloths for Stainless Steel (Box 10 Pcs)	\$ 29	\$ 34
KACL.959	Carbon.Zeo Filter Kit	\$ 109	\$ 129



## Down Draft



### Features

- 304 Stainless Steel
- Tempered Black Glass or Stainless Panel
- Piston Controlled Silent Opening
- Touch Control
- LED Lighting
- Top Filters are Removable and Washable
- Perimeter Suction
- Delayed Shut Off Option
- Optional Remote Control
- Optional Inline Blower Installation



	MODEL	COLOR	CFM	WIDTH	DUCT SIZE	MAP	MSRP
<b>NEW</b>	FDDOW36T6SS	SS	600	36"	6"	\$ 2,499	\$ 2,629
<b>NEW</b>	FDDOW36T6SGB	Black	600	36"	6"	\$ 2,499	\$ 2,629
<b>NEW</b>	FDNUVMTR600	Blower	600	Blower	Blower	\$ 449	\$ 479

\*Blower Required

## ACCESSORIES

MODEL	DESCRIPTION	MAP	MSRP
KACL.815	Protective Cleaning Cloths for Stainless Steel (Box 10 Pcs)	\$ 29	\$ 34
KACL.930	Carbon.Zeo Underbase Filter Kit	\$ 569	\$ 649
KACL.931	Carbon.Zeo Filter	\$ 349	\$ 389
105080053	Optional Remote Control	\$ 109	\$ 129

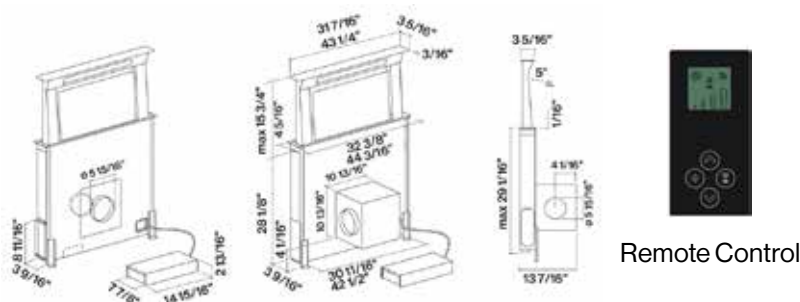





# POTENZA COLLECTION



## Vulcano

### Features

- Wall Mounted
- Speed Reduction System (600 CFM Models)
- 304 Stainless Steel
- 3 Speed Control (280 CFM Models)
- 4 Speed Control (600 CFM Models)
- LED Lighting
- Metallic Filters are Removable and Washable
- Delayed Shut Off Option
- Clean Filter Reminder



MODEL	Color	CFM	WIDTH	DUCT SIZE	MAP	MSRP
FPVUL24W3SS	SS	280	24"	6"	\$ 669	\$ 709
FPVUL30W3SS	SS	280	30"	6"	\$ 729	\$ 769
FPVUX30W6SS-R	SS	600/390/285	30"	6"	\$ 889	\$ 939
FPVUL36W3SS	SS	280	36"	6"	\$ 769	\$ 809
FPVUX36W6SS-R	SS	600/390/285	36"	6"	\$ 929	\$ 979

### DUCT COVERS

MODEL	DESCRIPTION	CEILING HEIGHT	MAP	MSRP
KACL.510#1	27" Duct Cover Extension	11'	\$ 189	\$ 209
KACL.512#1	38" Duct Cover Extension	12'	\$ 189	\$ 219

### ACCESSORIES

MODEL	DESCRIPTION	MAP	MSRP
KACL.815	Protective Cleaning Cloths for Stainless Steel (Box 10 Pcs)	\$ 29	\$ 34
101080245	24" Metallic Filter	\$ 39	\$ 44
101080143	30" Metallic Filter	\$ 39	\$ 49
101080246	36" Metallic Filter	\$ 39	\$ 44
FFCHASQCOBL	Square Charcoal Filter*	\$ 19	\$ 29

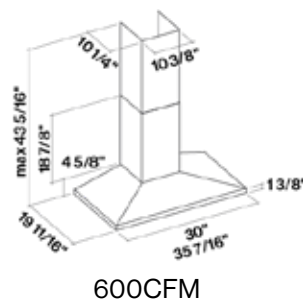
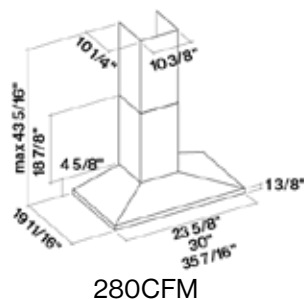

## Mercurio

### Features

- Wall or Island Mounted
- Speed Reduction System (600 CFM Models)
- 304 Stainless Steel
- 3 Speed Control (280 CFM Models)
- 4 Speed Control (600 CFM Models)
- LED Lighting
- Metallic Filters are Removable and Washable
- Recirculating Option
- Delayed Shut Off Option
- Clean Filter Reminder
- Optional Charcoal Filter



MODEL	Color	CFM	WIDTH	DUCT SIZE	MAP	MSRP
FPMER24W3SS	SS	280	24" - Wall	6"	\$ 669	\$ 709
FPMER30W3SS	SS	280	30" - Wall	6"	\$ 739	\$ 779
FPMEX30W6SS-R	SS	600/390/285	30" - Wall	6"	\$ 839	\$ 889
FPMER36W3SS	SS	280	36" - Wall	6"	\$ 769	\$ 809
FPMEX36W6SS-R	SS	600/390/285	36" - Wall	6"	\$ 839	\$ 889
FPMEX36I6SS-R	SS	600/390/285	36" - Island	6"	\$ 1,339	\$ 1,409
FPMEX42I6SS-R	SS	600/390/285	42" - Island	6"	\$ 1,399	\$ 1,469

### DUCT COVERS

MODEL	DESCRIPTION	CEILING HEIGHT	MAP	MSRP
KACL.510#1	27" Duct Cover Extension - Wall	11'	\$ 189	\$ 209
KACL.512#1	38" Duct Cover Extension - Wall	12'	\$ 189	\$ 219
KACL.557#1	48" Duct Cover Extension - Island	13'	\$ 399	\$ 459

### ACCESSORIES

MODEL	DESCRIPTION	MAP	MSRP
KACL.815	Protective Cleaning Cloths for Stainless Steel (Box 10 Pcs)	\$ 29	\$ 34
101080245	24" Metallic Filter	\$ 39	\$ 44
101080143	30" Metallic Filter	\$ 39	\$ 44
101080246	36" Metallic Filter	\$ 39	\$ 44
101079908	42" Metallic Filter	\$ 39	\$ 49
FFCHASQCOBL	Square Charcoal Filter	\$ 19	\$ 29

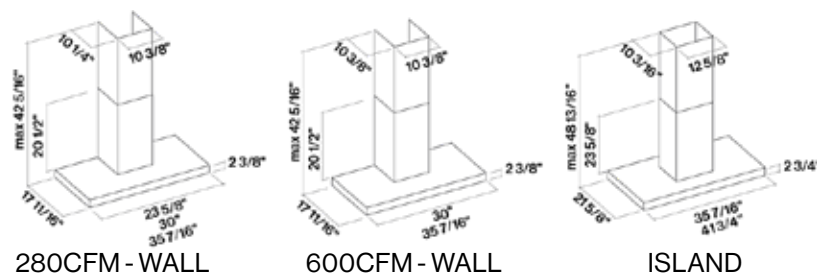

## Afrodite

### Features

- Wall Mounted
- 304 Stainless Steel
- 3 Speed Slider Control
- LED Lighting
- Metallic Filters are Removable and Washable



MODEL	Color	CFM	WIDTH	DUCT SIZE	MAP	MSRP
FPAFX30W6SS	SS	600	30"	6"	\$ 699	\$ 739
FPAFX36W6SS	SS	600	36"	6"	\$ 729	\$ 769

## ACCESSORIES

MODEL	DESCRIPTION	MAP	MSRP
KACL.815	Protective Cleaning Cloths for Stainless Steel (Box 10 Pcs)	\$ 29	\$ 34
101080243	30" Metallic Filter	\$ 39	\$ 44
101079900	36" Metallic Filter	\$ 19	\$ 29
FFCHAR3COBL	Round Charcoal Filter	\$ 29	\$ 39

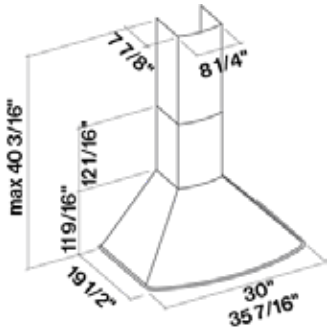

## Eros

### Features

- Under Cabinet
- Speed Reduction System
- 304 Stainless Steel
- 4 Speed Electronic Control
- LED Lighting
- Professional Baffle Filters
- Delayed Shut Off Option
- Clean Filter Reminder
- Recirculating Option



MODEL	COLOR	CFM	WIDTH	DUCT SIZE	MAP	MSRP
FPERO30U5SS-R	SS	500/390/285	30"	6"	\$ 969	\$ 1,019
<b>NEW</b> FPERO36U5SS-R	SS	500/390/285	36"	6"	\$ 1,029	\$ 1,089

*\*36" Model Available in June 2022*

### ACCESSORIES

MODEL	DESCRIPTION	MAP	MSRP
KACL.815	Protective Cleaning Cloths for Stainless Steel (Box 10 Pcs)	\$ 29	\$ 34
101080199	30" Baffle Filter	\$ 69	\$ 79
FFCHAR3COBL	Round Charcoal Filter	\$ 29	\$ 39

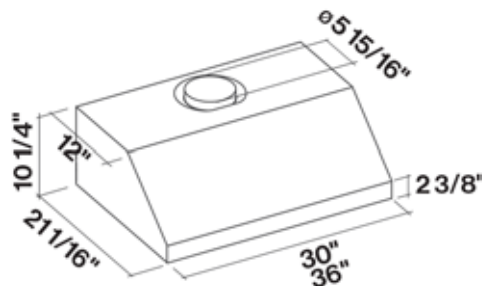





## Boreas Standard

### Features

- Under Cabinet
- 250 CFM
- 3 Speed Push Control
- Halogen Lighting
- Aluminum Filters
- Seamless Laser Welding
- Recirculation Kit Included

MODEL	COLOR	CFM	WIDTH	DUCT SIZE	MAP	MSRP
FPBOR30U2SS	SS	250	30"	6"	\$ 249	\$ 269
FPBOR30U2BL	Black	250	30"	6"	\$ 219	\$ 229



## Boreas Premium

### Features

- Under Cabinet
- 295 CFM
- 3 Speed Push Control
- LED Lighting
- Hybrid Filters (Baffle Mesh)
- Seamless Laser Welding
- Recirculation Kit Included

MODEL	COLOR	CFM	WIDTH	DUCT SIZE	MAP	MSRP
FPBOR30U3SS	SS	295	30"	6"	\$ 319	\$ 339
FPBOR30U3BL	Black	295	30"	6"	\$ 299	\$ 319

## ACCESSORIES

MODEL	DESCRIPTION	MAP	MSRP
KACL.815	Protective Cleaning Cloths for Stainless Steel (Box 10 Pcs)	\$ 29	\$ 34

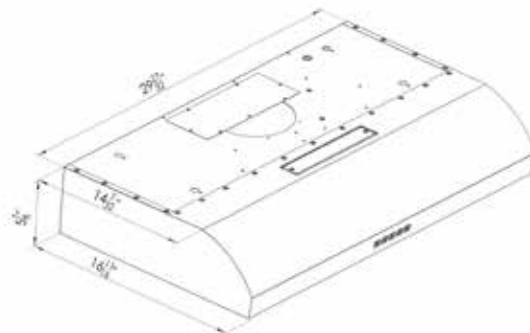

## Mercurio

### Features

- Built-In
- 304 Stainless Steel
- Mechanical Control
- LED Lighting
- Metallic Filters are Removable and Washable



MODEL	COLOR	CFM	WIDTH	DUCT SIZE	MAP	MSRP
FPMEU24B3SS	SS	280	24"	5"	\$ 579	\$ 609
FPMEU30B3SS	SS	280	30"	5"	\$ 599	\$ 629
FPMEU36B3SS	SS	280	36"	5"	\$ 629	\$ 669

## ACCESSORIES

MODEL	DESCRIPTION	MAP	MSRP
KACL.815	Protective Cleaning Cloths for Stainless Steel (Box 10 Pcs)	\$ 29	\$ 34
FFCHASQCOBL	Square Charcoal Filter	\$ 19	\$ 29

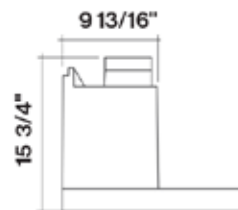
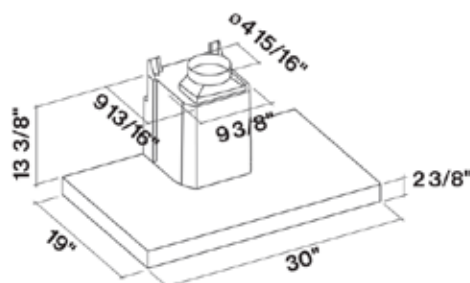



OUTDOOR  
COLLECTION





## Zeus Outdoor

### FEATURES

- Wall Mounted
- 31.5" Deep Canopy  
Ideal for Outdoor Spaces
- 304 Stainless Steel
- 3 Speed Motor
- LED Lighting
- Professional Baffle Filters
- Professional Knob Control

MODEL	COLOR	CFM	WIDTH	DUCT SIZE	MAP	MSRP
FOZEU36W12OS	SS	1200	36"	10"	\$ 2,399	\$ 2,519
FOZEU42W12OS	SS	1200	42"	10"	\$ 2,599	\$ 2,729
FOZEU48W12OS	SS	1200	48"	10"	\$ 2,699	\$ 2,839

## DUCT COVERS

MODEL	DESCRIPTION	CEILING HEIGHT	WIDTH	MAP	MSRP
KCPHN.001#IF	30" Duct Cover Extension	9.5'	36"	\$ 379	\$ 409
KCPHN.002#IF	30" Duct Cover Extension	9.5'	42"	\$ 434	\$ 469
KCPHN.003#IF	30" Duct Cover Extension	9.5'	48"	\$ 494	\$ 539
KCPHN.007#IF	60" Duct Cover Extension	9.5'	20"	\$ 514	\$ 559

## ACCESSORIES

MODEL	DESCRIPTION	MAP	MSRP
KACL.815	Protective Cleaning Cloths for Stainless Steel (Box 10 Pcs)	\$ 29	\$ 34

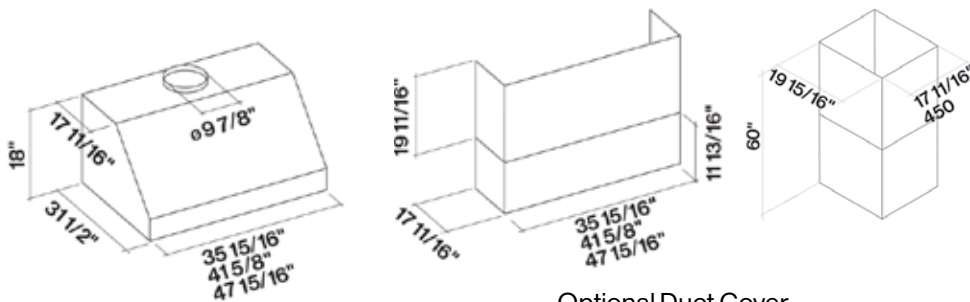

Optional Duct Cover

## Line Outdoor

### FEATURES

- Wall Mounted
- 31.5" Deep Canopy  
Ideal for Outdoor Spaces
- 304 Stainless Steel
- 3 Speed Motor
- LED Lighting
- Professional Baffle Filters
- Professional Knob Control



MODEL	COLOR	CFM	WIDTH	DUCT SIZE	MAP	MSRP
FOLIN36W12OS	SS	1200	36"	10"	\$ 2,499	\$ 2,629
FOLIN42W12OS	SS	1200	42"	10"	\$ 2,699	\$ 2,839
FOLIN48W12OS	SS	1200	48"	10"	\$ 2,849	\$ 2,999

## DUCT COVERS

MODEL	DESCRIPTION	CEILING HEIGHT	MAP	MSRP
KCPHN.007#IF	60" Duct Cover Extension	9.5'	\$ 204	\$ 229

## ACCESSORIES

MODEL	DESCRIPTION	MAP	MSRP
KACL.815	Protective Cleaning Cloths for Stainless Steel (Box 10 Pcs)	\$ 29	\$ 34

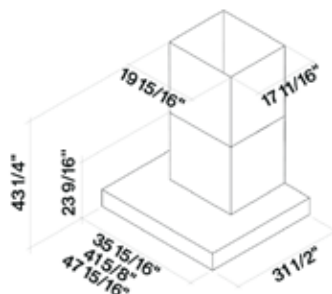

## Pyramid Outdoor

### FEATURES

- 31.5" Deep Canopy  
Ideal for Outdoor Spaces
- Wall Mounted
- 304 Stainless Steel
- 3 Speed Motor
- LED Lighting
- Professional Baffle Filters
- Professional Knob Control



MODEL	COLOR	CFM	WIDTH	DUCT SIZE	MAP	MSRP
FOPYR36W12OS	SS	1200	36"	10"	\$ 2,599	\$ 2,729
FOPYR42W12OS	SS	1200	42"	10"	\$ 2,749	\$ 2,889
FOPYR48W12OS	SS	1200	48"	10"	\$ 2,849	\$ 2,999

### DUCT COVERS

MODEL	DESCRIPTION	CEILING HEIGHT	MAP	MSRP
KCPHN.007#IF	60" Duct Cover Extension	9.5'	\$ 204	\$ 229

### ACCESSORIES

MODEL	DESCRIPTION	MAP	MSRP
KACL.815	Protective Cleaning Cloths for Stainless Steel (Box 10 Pcs)	\$ 29	\$ 34

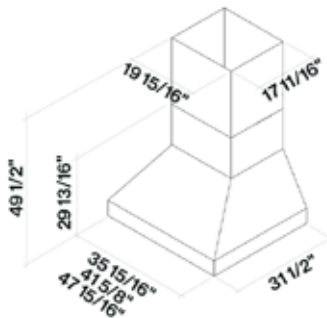



ACCESSORIES

## Recirculating Filter Fit Chart

Hood	Carbon Filter	Carbon.Zeo Filtering Kit	Carbon.Zeo Filtering Kit Replacement Filter
Afrodite	FFCHAR3C0BL	-	-
Built-in Mercurio	FFCHASQC0BL	-	-
Danilo	FFCHAR3C0BL	-	-
Down Draft	-	KACL.930	KACL.931
Eros	FFCHAR3C0BL	-	-
Incasso Burano	FFCHAR3C0BL	KACL.950	KACL.934
Incasso NRS	-	KACL.961	KACL.961
Line Pro NRS	-	KACL.961	KACL.961
Line Outdoor	-	-	-
Lumen Island	FFCHASQC0BL	KACL.949#IF	-
Lumen Wall	FFCHASQC0BL	KACL.948#IF	-
Lumen Island 175	FFCHASQC0BL	KACL.949#IF	-
Lumina NRS	-	KACL.961	KACL.961
Mara	FFCHAR3C0BL	-	-
Massimo Pro	FFCHAR3C0BL	-	-
Massimo Pro XL	2 X FFCHAR3C0BL	-	-
Massimo Pro NRS	-	KACL.961	KACL.961
Mercurio	FFCHASQC0BL	-	-
Mira Wall	FFCHASQC0BL	-	-
Mira Island	FFCHAR3C0BL	-	-
Move	-	KACL.961	KACL.961
Plane Top	FFCHASQC0BL	KACL.948#IF	-
Plane NRS	-	KACL.961	KACL.961
Polar	FFCHAR3C0BL	-	-
Polar Black/White	2 X FFCHAR3C0BL	-	-
Prestige	FFCHAR3C0BL	-	-
Prisma	FFCHAR3C0BL	KACL.941	-
Pyramid Outdoor	-	-	-
Pyramid Pro	-	-	-
Pyramid Pro NRS	-	KACL.948#IF	-
Rialto Top	FFCHAR3C0BL	-	-
Sabina	FFCHAR2C0BL	-	-
Valentina	FFCHAR3C0BL	-	-
Verso NRS	-	KACL.959	-
Virgola	FFCHASQC0BL	KACL.950	KACL.934
Vittorio Pro	FFCHAR3C0BL	-	-
Vulcano	FFCHASQC0BL	-	-
Zeus Pro	-	-	-
Zeus Pro NRS	-	KACL.948#IF	-
Zeus Pro Outdoor	-	-	-

## Filters

### ANTI-GREASE FILTERS



#### Metallic Filters

The anti-grease filter serves the important purpose of trapping grease.

Falmec metal filters have been specifically designed to guarantee excellent grease capture. They have an internal multi-layer aluminum structure composed of corrugated mesh (to maximize the filtering surface).

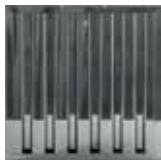

#### Professional Baffle Filters

Baffle filters are fitted as standard in all hoods in the Professional collection. Adopted from the world of professional cooking, their unique structure means that oils and vapors are condensed and channelled into a tray that can be easily removed and cleaned.

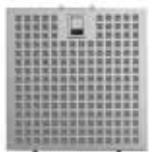

#### Top Filters

Top grease filters maintain the high retention performance of the metal filters with the addition of a "chessboard" external frame in 304 stainless steel with a smooth surface that facilitates cleaning and at the same time qualifies the aesthetic appearance.

MODEL	DESCRIPTION	MAP	MSRP
101080154	Aluminum Filter	\$ 19	\$ 29
101078704	Metallic Filter	\$ 49	\$ 59
101079908	42" Metallic Filter, Mercurio	\$ 39	\$ 49
101080097	Metallic Filter, Rialto Top, Small Single Filter	\$ 29	\$ 39
101080138	22" Metallic Filter, Mara	\$ 29	\$ 39
101080139	28" Metallic Filter, Mara	\$ 29	\$ 39
101080140	28" Metallic Filter, Valentina, Sabina	\$ 29	\$ 39
101080141	34" Metallic Filter, Valentina	\$ 29	\$ 39
101080143	30" Metallic Filter, Mercurio, Vulcano	\$ 39	\$ 49
101080145	22" Metallic Filter, Sabina	\$ 19	\$ 29
101080153	30" Metallic Filter, Built-In Mercurio	\$ 19	\$ 29
101080204	30" Metallic Filter, Plane NRS	\$ 59	\$ 69
101080205	Metallic Filter, Prisma	\$ 59	\$ 69
101080246	36" Metallic Filter, Mercurio, Vulcano, BI Mercurio	\$ 39	\$ 44
101080247	Metallic Filter, Flipper	\$ 39	\$ 44
101080250	Metallic filter, Move	\$ 29	\$ 39
KACL.841#I	Metallic Filter, Polar	\$ 109	\$ 129
KACL.844#I	20" Metallic Filter, Gruppo Incasso NRS	\$ 89	\$ 109
KACL.845#I	28" Metallic Filter, Gruppo Incasso NRS	\$ 69	\$ 79
101080197	Standard Baffle Filter, Danilo	\$ 79	\$ 99
101080199	30" Baffle Filter, Eros	\$ 69	\$ 79
101080196	Baffle Filter 18" Deep for Professional	\$ 99	\$ 109
101078604	28" Baffle Filter, Massimo Pro	\$ 99	\$ 109
101080200	Standard Baffle Filter - Island	\$ 79	\$ 99

## Filters

### RECIRCULATING FILTERS



MODEL	DESCRIPTION	MAP	MSRP
FFCHASQC0BL	Square Charcoal Filter	\$ 19	\$ 29
FFCHAR3COBL	Round Charcoal Filter	\$ 29	\$ 39
FFCHAR2COBL	Round Charcoal Filter	\$ 29	\$ 39

### Active Carbon Filters

Active Carbon filters are installed in all hoods that can be used in filter mode. The active carbons they contain absorb odors created by cooking.

As the filters become less efficient with time, replacement at least every four months is recommended.



### Combined High Performance Filters (Silence - NRS Collection)

Wash in dishwasher with your usual detergent at a temperature not exceeding 149°F, if possible with no other contents. After washing, regenerate the filter in the oven at 175°F for 20 minutes.



MODEL	DESCRIPTION	MAP	MSRP
KACL.934	Carbon.Zeo Filter (Incasso Burano, Virgola)	\$ 139	\$ 159
KACL.930	Carbon.Zeo Underbase Filter Kit (Down Draft)	\$ 569	\$ 649
KACL.939#BF	Ceiling Recirculation Filter Pack (Nuvola 90, Nuvola 140, Stella, Nube)	\$ 889	\$ 959
KACL.941	Carbon Zeo Filter (Prisma)	\$ 379	\$ 429
KACL.948#IF	Carbon.Zeo Filter Kit - Wall Version (Lumen Wall, Plane Top, Pyramid Pro NRS, Zeus Pro NRS)	\$ 399	\$ 439
KACL.949#IF	Carbon.Zeo Filter Kit - Island Version (Lumen Island, Lumen Island 175)	\$ 529	\$ 569
KACL.950	Carbon.Zeo Lite Filter Unit (Incasso Burano, Virgola)	\$ 319	\$ 369
KACL.953#BF	Carbon.Zeo Filter Kit - Vertical Ceiling (Pyramid Pro NRS, Line Pro NRS, Nuvola 90, Nuvola 140, Stella, Nube)	\$ 789	\$ 849
KACL.959	Carbon.Zeo Filter Kit (Verso NRS)	\$ XX	\$ XX
KACL.961	Carbon.Zeo Filter Kit (Incasso NRS, Line Pro NRS, Lumina NRS, Massimo Pro NRS, Move, Plane NRS)	\$ 109	\$ 129

### Carbon.Zeo Filters

Carbon.Zeo filters use natural materials such as active carbon and zeolite, a mineral of volcanic origin with a microporous crystalline molecular structure that absorbs fumes and unpleasant odors.

The Carbon.Zeo combined filter has a guaranteed minimum life of 3 years, but is expected to last 5 years under conditions of normal use. We recommend that it be regenerated every 18 months by placing it in an oven at 400°F for two hours.

## Blowers

### REMOTE BLOWER



MODEL	DESCRIPTION	MAP	MSRP
FNUVMTR600	600 CFM Blower	\$ 449	\$ 479

### 600 CFM Remote Blower

A remote ventilation fan is the right choice if you want to reduce the noise of your hood, by distancing the source of the noise, without compromising on extraction performance. Available in select models

### MAGIC STEEL



MODEL	DESCRIPTION	MAP	MSRP
KACL.815	Protective Cleaning Cloths for Stainless Steel (Box 10 Pcs)	\$ 29	\$ 34



## Accessories

MODEL	DESCRIPTION	MAP	MSRP
101080154	Aluminum Filter	\$ 19	\$ 29
101078704	Metallic Filter	\$ 49	\$ 59
101079908	42" Metallic Filter, Mercurio	\$ 39	\$ 49
101080097	Metallic Filter, Rialto Top, Small Single Filter	\$ 29	\$ 39
101080138	22" Metallic Filter, Mara	\$ 29	\$ 39
101080139	28" Metallic Filter, Mara	\$ 29	\$ 39
101080140	28" Metallic Filter, Valentina, Sabina	\$ 29	\$ 39
101080141	34" Metallic Filter, Valentina	\$ 29	\$ 39
101080143	30" Metallic Filter, Mercurio, Vulcano	\$ 39	\$ 49
101080145	22" Metallic Filter, Sabina	\$ 19	\$ 29
101080153	30" Metallic Filter, Built-In Mercurio	\$ 19	\$ 29
101080204	30" Metallic Filter, Plane NRS	\$ 59	\$ 69
101080205	Metallic Filter, Prisma	\$ 59	\$ 69
101080246	36" Metallic Filter, Mercurio, Vulcano, BI Mercurio	\$ 39	\$ 44
101080247	Metallic Filter, Flipper	\$ 39	\$ 44
101080250	Metallic filter, Move	\$ 29	\$ 39
KACL.841#I	Metallic Filter, Polar	\$ 109	\$ 129
KACL.844#I	20" Metallic Filter, Gruppo Incasso NRS	\$ 89	\$ 109
KACL.845#I	28" Metallic Filter, Gruppo Incasso NRS	\$ 69	\$ 79
101080197	Standard Baffle Filter, Danilo	\$ 79	\$ 99
101080199	30" Baffle Filter, Eros	\$ 69	\$ 79
101080196	Baffle Filter 18" Deep for Professional	\$ 99	\$ 109
101078604	28" Baffle Filter, Massimo Pro	\$ 99	\$ 109
101080200	Standard Baffle Filter - Island	\$ 79	\$ 99
KACL.934	Carbon.Zeo Filter, Move	\$ 139	\$ 159
KACL.941	Carbon.Zeo Filter, Flipper, Quasar, Prisma	\$ 379	\$ 429
105080053	Remote Control	\$ 109	\$ 129
FDPGL36I0TG	Glass Kit, Polar Island	\$ 249	\$ 289
FDPGL36W0TG	Glass Kit, Polar Wall	\$ 249	\$ 269
KACL.107	Optional Glass Shelf for 36" Move	\$ 159	\$ 169
KACL.789	Side Junction for Ceiling, Stella, Nuvola 90, Nuvola 140, Nube	\$ 89	\$ 109

## FALMEC LIMITED WARRANTY

### TWO YEARS LIMITED WARRANTY

#### TO OBTAIN SERVICE UNDER WARRANTY

Owner must present proof of original purchase date. Please keep a copy of your dated proof of purchase (sales slip) in order to obtain service under warranty.

#### PARTS AND SERVICE WARRANTY

For the period of two (2) years from the date of the original purchase, Falmec will provide, free of charge, non consumable parts or components that failed due to manufacturing defects. During this two (2) years limited warranty, Falmec will also provide, free of charge, all labor and in-home service to replace any defective parts.

#### WHAT IS NOT COVERED

- An extraordinary event neither foreseeable nor preventable by the parties with reasonable care, including, but not limited to: catastrophe, war, expropriation of equipment or installation, sabotage, fire, flood, tornado, hurricane, earthquake.
- Damage to or failure of the product:
- Caused by modification of the product or use of non-genuine parts.
- Caused during delivery, handling or installation.
- Caused by operator abuse / misuse.
- Caused by dwelling fuse replacement or resetting of circuit breakers.
- Caused by use of product in a commercial / industrial application.
- Service trips to dwelling to provide use or installation guidance.
- Light bulbs, metal or carbon filters and any other consumable part.
- Normal wear of finish.
- Wear to finish due to operator abuse, improper maintenance, use of corrosive or abrasive cleaning products / pads and oven cleaner products.

#### WHO IS COVERED

This warranty is extended to the original purchaser for products purchased for ordinary residential use in United States, Guam, Puerto Rico, US Virgin Islands).

This warranty is non-transferable and applies only to the original purchaser and does not extend to subsequent owners of the product. This warranty is made expressly in lieu of all other warranties, expressed or implied, including, but not limited to any implied warranty of merchantability or fitness for a particular purpose and all other obligations on the part of Falmec North America, provided, however, that if the disclaimer of implied warranties is ineffective under applicable law, the duration of any implied warranty arising by operation of law shall be limited to two (2) years from the date of original purchase at retail or such longer period as may be required by applicable law.

This warranty does not cover any special, incidental and / or consequential damages, nor loss of profits, suffered by the original purchaser, its customers and / or the users of the Products.

#### WHO TO CONTACT

For proof of warranty, please retain the original purchase invoice and the delivery slip.

To obtain service under this warranty you must:

1. Contact Falmec Authorized Service In the United States by email at [support@mapledistributing.com](mailto:support@mapledistributing.com) or by toll free number at **800-866-4774**
2. Provide a copy of your original sales receipt along with model number and serial number information for the product.
3. Provide Falmec reasonable opportunity to investigate the claim before the Product or any component of the Product has been modified or removed.





**Maple Distributing, LLC**

2100 Century Cir • Irving, TX • 75062

Phone: 800-866-4774

Fax: 214-352-0348

[orders@mapledistributing.com](mailto:orders@mapledistributing.com)

[www.mapledistributing.com](http://www.mapledistributing.com)