



Fulgor Milano List Price Book

Effective March 1, 2024

www.mapledistributing.com

800-866-4774

A little about Fulgor Milano...

- 1949 Fulgor is founded as a coal-stove factory
- 1955 Fulgor first produces freestanding gas kitchen ranges
- 1974 Fulgor's built-in cooktops are created
- 1976 Fulgor's electric built-in ovens are first produced
- 1990 Creation of Fulgor's first built-in glass cooktop
- 1991 First European production of Fulgor's pyrolytic ovens
- 1994 First production of Fulgor's pyrolytic ovens for the North American market
- 2006 Meneghetti invents world's first dual-flame burner
- 2009 Fulgor celebrates 60 years; Fulgor Milano is born. A complete line of premium built-in appliances.
- 2016 Fulgor Milano introduced to North America
- 2024 Fulgor Milano celebrates 75 years



TABLE OF CONTENTS

	Page
About Fulgor Milano	2
Why Fulgor Milano?	6
NEW Color Bezel Kits	8
Meet the 48" Sofia Range	10
Explore our Built-In Refrigerator	11
Crescendo Burner	12
Ranges	14
Sofia Ranges	15
Accento Ranges	24
Rangetops	27
Gas Rangetops	28
Induction Rangetops	32
Cooktops	35
Gas Cooktops	36
Induction Cooktops	44
Radiant Cooktops	47
Ovens	49
Wall Ovens	50
Specialty Ovens	61
Warming Drawers	65
Microwave Ovens	66
Coffee Systems	70
Refrigeration	72
Column Refrigeration	75
Built-in Refrigeration	78
Freestanding Refrigeration	81
Dishwashers	83
Ventilation	89
Fulgor Milano Warranty and Service Information	96
Maple Distributing Terms & Conditions of Sale	97

Fulgor Milano, an Italian brand by Meneghetti SPA, has been synonymous with excellence and innovation in the world of cooking since 1949. When Fulgor Milano became part of the Meneghetti family in 2009, the brand united its devotion to creativity with expert knowledge in the creation of premium built-in appliances.



A perfect balance of elegance, design, function and performance, this professional cooking line will satisfy the most discerning chef, while still providing a center piece for any kitchen design.

We invite you to explore Fulgor Milano premium kitchen appliances.



Why

FULGOR

MILANO



»» **SOFIA IS AN INDIVIDUAL (DESIGN)**

Fulgor Milano designed a professional range with a style and presence unique to her name. Sofia integrates the use of stainless steel and brushed aluminum for a design that is elegant and distinctive.

»» **PROFESSIONALLY CRAFTED (FIT, FINISH, QUALITY)**

This multifunction range, combines all the features of a fully-equipped professional range with a stainless steel design which highlights the elegance and uniqueness of Italian style.

»» **CRESCENDO BURNERS**

Because precision is important for powerful high and gentle low flames, our sealed burners offer five combinations of flame configurations for near infinite control. Durable brass burner rings provide exceptional heat distribution to the base of the cooking vessel at its maximum output of 20,000 BTUs and is also capable of the gentlest simmer aided by its oversized burner cap.

»» **TOTAL CONTROL AND DELICATE POWER**

Every aspect of Sofia is beautiful and her gas cooking surface is no exception. Every burner allows you to temper the most delicate chocolate or sear a steak to perfection.

»» **CAST IRON GRATES AND MATTE BURNER BASIN**

Heavy-duty cast-iron grates form a continuous surface for easy movement of pots and pans. You'll barely notice spillovers in this recessed burner basin and they'll clean up easily, too.

»» **ROBUST CONTROL KNOBS**

A perfect match for the bold design of the control panel, robust brushed metal knobs ensure easy handling and precise control while cooking.

»» **PERSONALIZE YOUR KITCHEN**

Customize your Sofia kitchen with a name that speaks to you. Visit the Fulgor Milano website and design a nameplate for your oven door. This unique, complimentary addition will be shipped directly to your home, making your Sofia kitchen unmistakably yours. You can also tailor your space by selecting from an array of 7 finishes for your range and 3 distinct options for your bezel and nameplate finishes, ensuring every detail reflects your personal style.

»» **CRAFTED IN ITALY**

Made in Italy with a perfect balance of elegance, design, function and performance, this professional cooking brand will satisfy the most discerning chef, while still providing a center piece for any kitchen design.

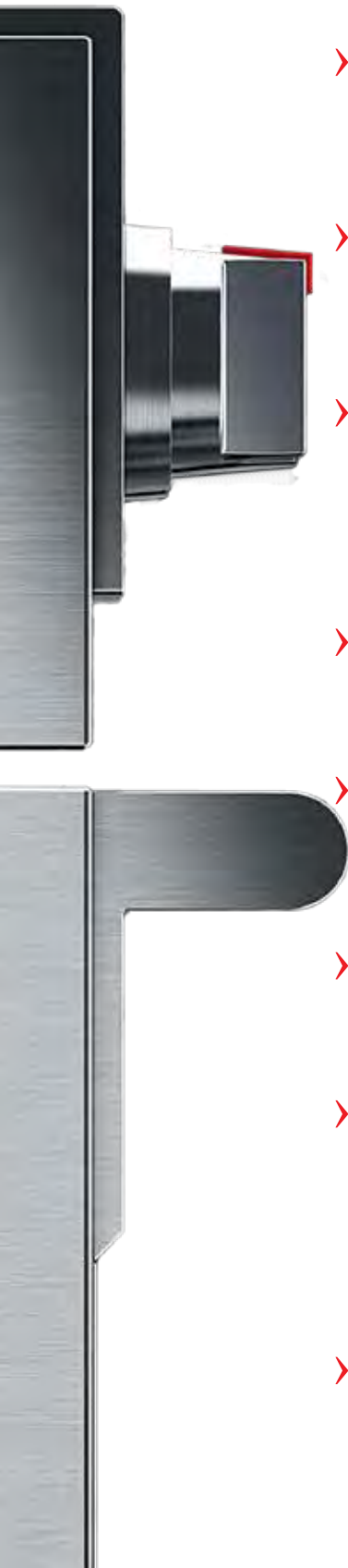





NEW

FOR 2024

COLOR BEZEL KITS

FOR SOFIA RANGES, RANGETOPS AND WALL OVENS

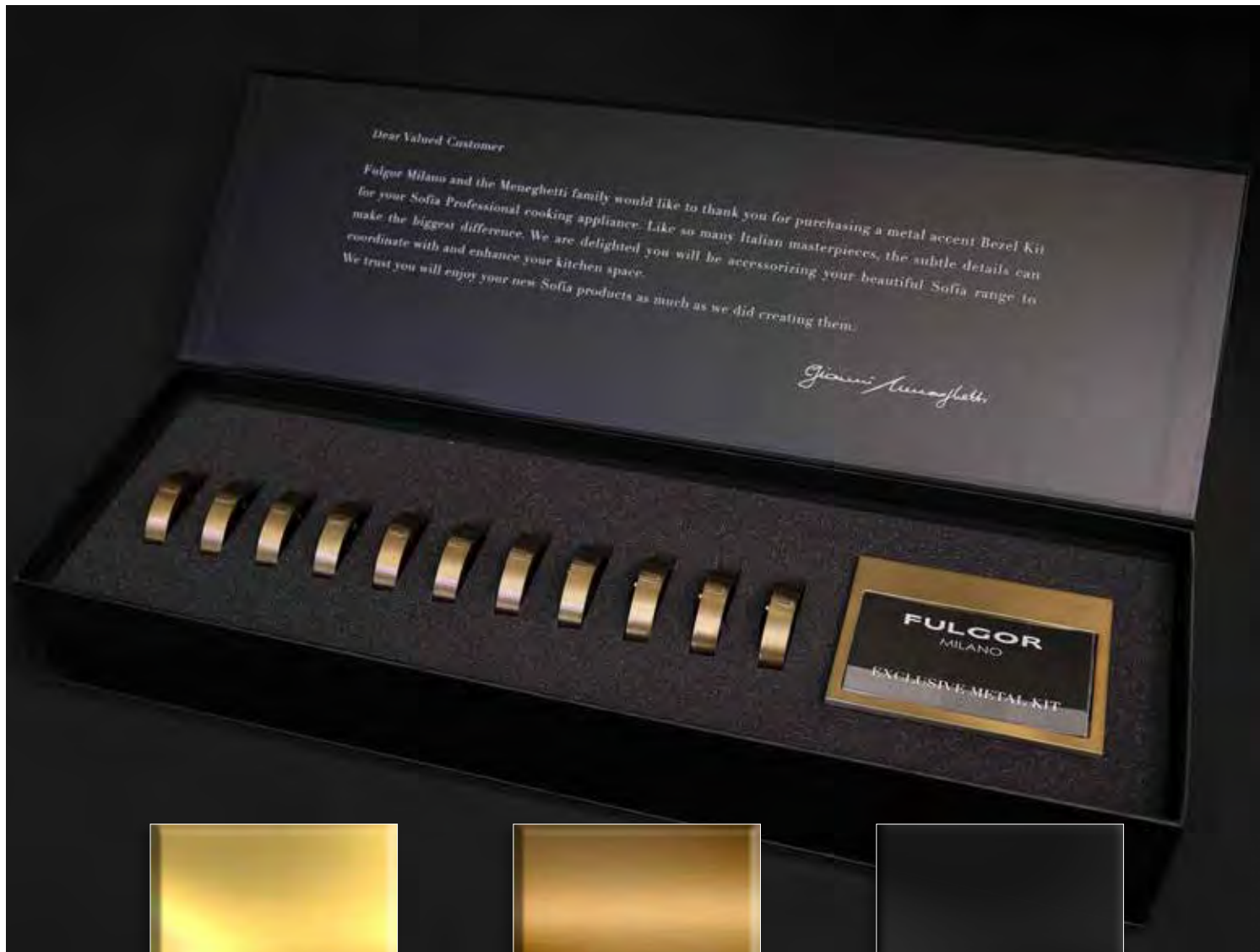

VENETIAN BRASS

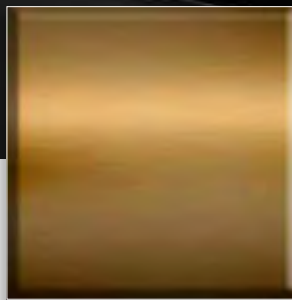

BRUSHED BRONZE



MATTE BLACK

- Please note that actual finishes may vary slightly from those depicted in our price book due to variations in screen settings and the nature of the material.

THE 48" **SOFIA** RANGE

Thoughtfully designed surface cooking with six burner positions, each with a 5-in-1 Crescendo burner beneath continuous cast iron grates and a Trilaminare stainless steel griddle, providing unparalleled power and control to melt, simmer, sauté and sear as you desire. Below the cooking surface, two self cleaning convection ovens with intuitive multiple baking and broiling functions and the convenience of telescoping racks encourages you to cook the way you want.

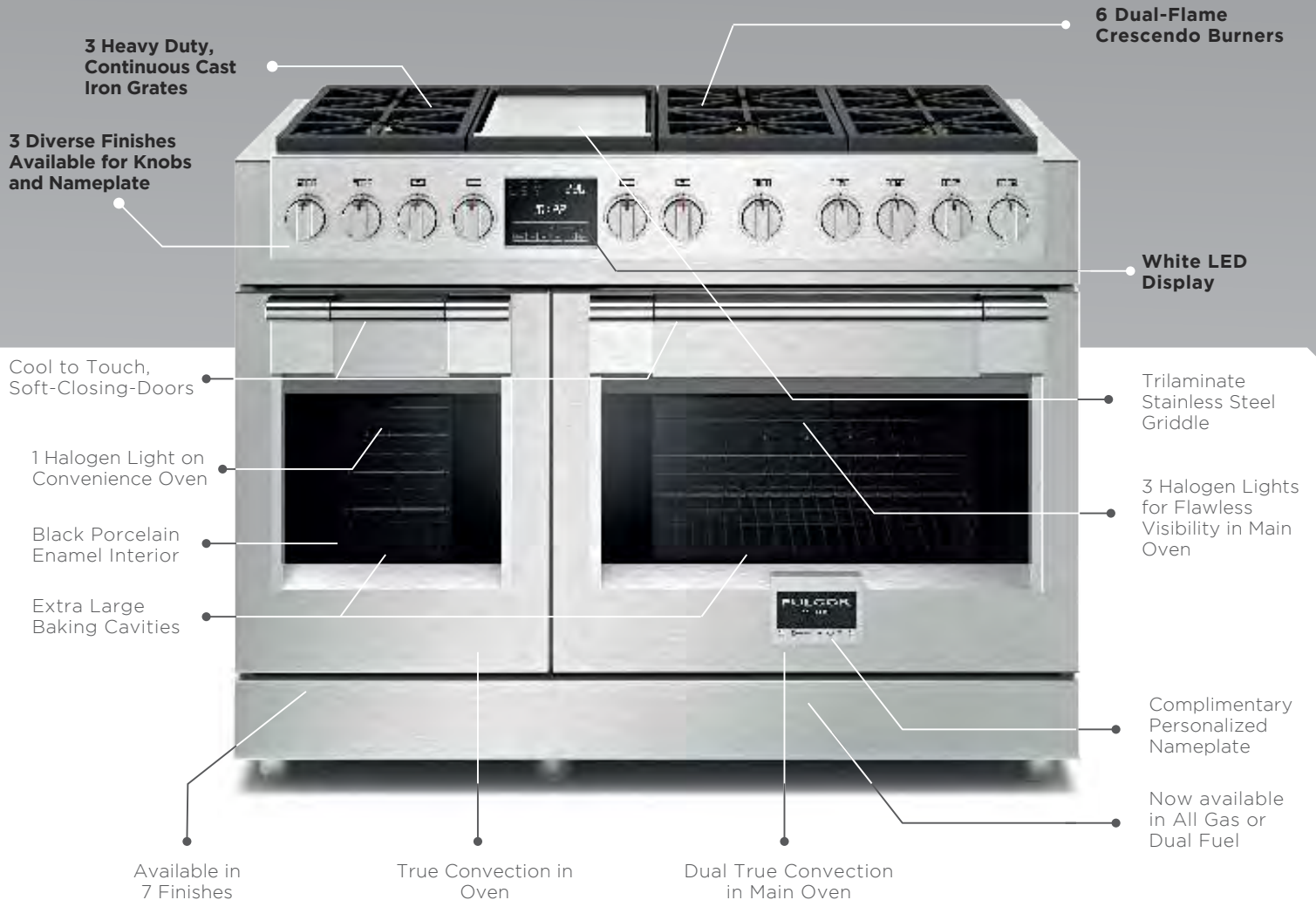

EXPLORE OUR NEW COLUMN REFRIGERATION



5 *in* 1

CRESCENDO BURNER



Because precision is important for powerful high and gentle low flames, our sealed burners offer five combinations of flame configurations for near infinite control. Durable brass burner rings provide exceptional heat distribution to the base of the cooking vessel at its maximum output of 20,000 BTU and is also capable of the gentlest simmer aided by its oversized burner cap.



FORTE

1

At the peak of its 20,000 BTU capability, meat is seared to produce a crust worthy of your favorite chef. Large pots quickly recover to a rigorous boil, and no culinary conquest seems unattainable. All burner rings engage to produce the most powerful flame for cooking.



MEZZOFORTE

2

Perfect al dente pasta is a snap. Progressive control of the burner ensures maximum heat distribution without excessive flame for an even and moderate boil.



MEZZO

3

Creamy risotto and smooth custards come to life as the burner rings combine to provide enough heat to encourage the cooking but discourage scorching.



PIANOFORTE

4

Simmer, poach, or braise your way to a tender sauce, soup or stew. Flame curls around the diffuser cap to barely brush the base of the cooking vessel with perfect control for extended periods of low heat cooking.



PIANO

5

Melt butter, temper chocolate, or gently coax the flavor from savory vegetables, this lowest setting is achieved by the flame from the simmer burner rolling gently under the diffuser cap to radiate whisper soft heat.



RANGES

SOFIA FREESTANDING RANGES - DUAL FUEL

SOFIA
Professional 600
Freestanding



F6PDF304S1

30" Dual Fuel Professional Range
Series: 600
AVAILABLE IN 7 FINISHES



RANGES

Cooking Surface

- 2 Heavy Duty, Continuous Cast Iron Grates
- One Piece, Matte Finish Porcelain Burner Bowl
- 4 Dual-Flame Crescendo Burners
- 1 Burner Provides Maximum 20,000 BTUs of Power
- 3 Burners Provide Maximum 18,000 BTUs of Power
- Simmer Setting adjustable to 375 BTUs
- Standard Natural Gas, LP Conversion Kit Included
- Cast Iron Island Trim

Oven

- Dual True Convection
- Self-Cleaning Oven with Multifunctioning Baking
- Black Porcelain Enamel Interior
- Cool to Touch, Soft-Closing Door
- Extra Large Baking Cavity
- 3 Halogen Lights for Flawless Visibility
- 4.4 cu. ft. Capacity
- 2 Chrome Racks
- 1 Telescopic Rack
- Enameled Broiler Pan
- Meat Probe
- Complimentary Personalized Nameplate
- "Sabbath Mode"



Product Information

MODEL	WIDTH	FINISH	DESCRIPTION	UMRP
F6PDF304S1	30"	Stainless Steel	Dual Fuel Professional Range	\$ 6,499

Optional Accessories

MODEL	DESCRIPTION	UMRP
PDRKIT30MG	Color Door Kit, Matte Slate Gray	\$ 1,119
PDRKIT30WH	Color Door Kit, Glossy White	\$ 1,119
PDRKIT30MW	Color Door Kit, Matte White	\$ 1,119
PDRKIT30RD	Color Door Kit, Glossy Red	\$ 1,119
PDRKIT30BK	Color Door Kit, Glossy Black	\$ 1,119
PDRKIT30MB	Color Door Kit, Matte Black	\$ 1,119
NEW FMSBEZKIT06-BR	Small Bezel Kit for 30" Ranges, Venetian Brass	\$ 429
NEW FMSBEZKIT06-BZ	Small Bezel Kit for 30" Ranges, Brushed Bronze	\$ 429
NEW FMSBEZKIT06-MB	Small Bezel Kit for 30" Ranges, Matte Black	\$ 429
F6BG30ISL	30" Back Guard, Island Trim	\$ 149
F6BG30STD	30" Back Guard, Standard 3" Trim	\$ 229
F6BG30HBT	30" Back Guard, 9" Highback Trim	\$ 319
F6BG30BCI	30" Back Guard, Cast Iron Island Trim	\$ 159
FMWOK	Wok Ring	\$ 69
FMSIM	Simmer Plate	\$ 89
FMGRID30	Griddle, 30"	\$ 239
FMTRP30	Telescopic Rack, 30" Range	\$ 229
FMHAK30	High Altitude Kit, 30" Range	\$ 59

SOFIA FREESTANDING RANGES - DUAL FUEL

F6PDF366S1 / F6PDF364GS1

36" Dual Fuel Professional Range
Series: 600
AVAILABLE IN 7 FINISHES



SOFIA
Professional 600
Freestanding

Cooking Surface

- 3 Heavy Duty, Continuous Cast Iron Grates -OR- 2 Heavy Duty, Continuous Cast Iron Grates with Trilaminar Stainless Steel Griddle w/ Tubular Burner
- One Piece Matte Finish Porcelain Burner Bowl
- 4-6 Dual-Flame Crescendo Burners
- 2 Burners Provide Maximum 20,000 BTUs of Power
- 2-4 Burners Provide Maximum 18,000 BTUs of Power
- Simmer Setting adjustable to 375 BTUs
- Standard Natural Gas, LP Conversion Kit Included
- Cast Iron Island Trim

Oven

- Dual True Convection
- Self Cleaning Oven with Multifunction Baking
- Black Porcelain Enamel Interior
- Cool to Touch, Soft-Closing Door
- Extra Large Baking Cavity
- 3 Halogen Lights for Flawless Visibility
- 5.7 cu. ft. Capacity
- 2 Chrome Racks
- 1 Telescopic Rack
- Enameled Broiler Pan
- Meat Probe
- Complimentary Personalized Nameplate "Sabbath Mode"



Product Information

MODEL	WIDTH	FINISH	DESCRIPTION	UMRP
F6PDF366S1	36"	Stainless Steel	Dual Fuel Professional Range	\$ 8,499
F6PDF364GS1	36"	Stainless Steel	Dual Fuel Professional Range with Griddle	\$ 9,299

Optional Accessories

MODEL	DESCRIPTION	UMRP
PDRKIT36MG	Color Door Kit, Matte Slate Gray	\$ 1,229
PDRKIT36WH	Color Door Kit, Glossy White	\$ 1,229
PDRKIT36MW	Color Door Kit, Matte White	\$ 1,229
PDRKIT36RD	Color Door Kit, Glossy Red	\$ 1,229
PDRKIT36BK	Color Door Kit, Glossy Black	\$ 1,229
PDRKIT36MB	Color Door Kit, Matte Black	\$ 1,229
NEW FMSBEZKIT11-BR	Large Bezel Kit for 36" Ranges, Venetian Brass	\$ 539
NEW FMSBEZKIT11-BZ	Large Bezel Kit for 36" Ranges, Brushed Bronze	\$ 539
NEW FMSBEZKIT11-MB	Large Bezel Kit for 36" Ranges, Matte Black	\$ 539
F6BG48STD	48" Back Guard, Standard 3" Trim	\$ 239
F6BG48HBT	48" Back Guard, 9" Highback Trim	\$ 409
F6BG48BCI	48" Back Guard, Cast Iron Island Trim	\$ 229
FMWOK	Wok Ring	\$ 69
FMSIM	Simmer Plate	\$ 89
FMGRID36	Griddle, 36"	\$ 219
FMTRP36	Telescopic Rack, 36" Range	\$ 249
FMHAK36	High Altitude Kit, 36" Range	\$ 59

SOFIA Professional 600

Freestanding 600



SOFIA FREESTANDING RANGES - DUAL FUEL

F6PDF486GS1

48" Dual Fuel Professional Range
Series: 600
AVAILABLE IN 7 FINISHES



RANGES

Cooking Surface

- 3 Heavy Duty, Continuous Cast Iron Grates
- Trilaminar Stainless Steel Griddle with Tubular Gas Burner
- Griddle Performs at 11,500 BTUs on High and 2,000 BTUs on Low
- One Piece, Matte Finish Porcelain Burner Bowl
- 6 Dual-Flame Crescendo Burners
- 2 Burners Provide Maximum 20,000 BTUs of Power
- 4 Burners Provide Maximum 18,000 BTUs of Power
- Simmer Setting adjustable to 375 BTUs
- Standard Natural Gas, LP Conversion Kit Included
- Cast Iron Island Trim

Oven

- Dual True Convection in Main Oven
- True Convection in Accessory Oven
- Self-Cleaning Ovens with Multifunction Baking
- Black Porcelain Enamel Interior
- Cool to Touch, Soft-Closing Door
- Extra Large Baking Cavity
- 3 Halogen Lights on Main Oven
- 1 Halogen Light on Accessory Oven
- 4.4 CuFt on Main Oven, 2.7 CuFt on Accessory Oven
- 2 Chrome Racks / 1 Telescopic Rack Per Oven
- Meat Probe (Main Oven)
- Complimentary Personalized Nameplate
- "Sabbath Mode"

Product Information

MODEL	WIDTH	FINISH	DESCRIPTION	UMRP
F6PDF486GS1	48"	Stainless Steel	Dual Fuel Professional Range	\$ 12,499

Optional Accessories

MODEL	DESCRIPTION	UMRP
PDRKIT48MG	Color Two Door Kit, Matte Slate Gray	\$ 1,919
PDRKIT48WH	Color Two Door Kit, Glossy White	\$ 1,919
PDRKIT48MW	Color Two Door Kit, Matte White	\$ 1,919
PDRKIT48RD	Color Two Door Kit, Glossy Red	\$ 1,919
PDRKIT48BK	Color Two Door Kit, Glossy Black	\$ 1,919
PDRKIT48MB	Color Two Door Kit, Matte Black	\$ 1,919
NEW FMSBEZKIT11-BR	Large Bezel Kit for 48" Ranges, Venetian Brass	\$ 539
NEW FMSBEZKIT11-BZ	Large Bezel Kit for 48" Ranges, Brushed Bronze	\$ 539
NEW FMSBEZKIT11-MB	Large Bezel Kit for 48" Ranges, Matte Black	\$ 539
F6BG48STD	Back Guard, 48", 3" Stainless Steel Trim*	\$ 219
F6BG30STD	Back Guard, 30", 3" Standard Trim*	\$ 229
F6BG48BCI	Back Guard, 48", Standard Cast Iron Island Trim*	\$ 209
F6BG48HBT	Back Guard, 48", 9" High Back Trim*	\$ 379
FMWOK	Wok Ring	\$ 69
FMSIM	Simmer Plate	\$ 89
FMTRP30	Telescopic Rack, 30" Main Oven	\$ 229
FMTRP18	Telescopic Rack, 18" Accessory Oven	\$ 219
FMHAK48	High Altitude Kit, 48" Range	\$ 69

SOFIA FREESTANDING RANGES - ALL GAS

F6PGR304S2

30" All Gas Professional Range
Series: 600
AVAILABLE IN 7 FINISHES



SOFIA
Professional Freestanding 600



Cooking Surface

- 2 Heavy Duty, Continuous Cast Iron Grates
- One Piece Matte Finish Porcelain Burner Bowl
- 4 Dual-Flame Crescendo Burners
- 1 Burner Provides Maximum 20,000 BTUs of Power
- 3 Burners Provide Maximum 18,000 BTUs of Power
- Standard Natural Gas, LP Conversion Kit Included
- Simmer Setting adjustable to 375 BTUs
- Cast Iron Island Trim

Oven

- Dual Convection
- Nova Broiler System
- Black Porcelain Enamel Interior
- Cool to Touch, Soft Closing Door
- Extra Large Baking Cavity
- 3 Halogen Lights for Flawless Visibility
- Glow Plug Ignition
- 4.4 cu. ft. Capacity
- 2 Chrome Racks
- 1 Telescopic Rack
- Enameled Broiler Pan
- Complimentary Personalized Nameplate
- Oven Temperature Electronic Control
- "Sabbath Mode"



Product Information

MODEL	WIDTH	FINISH	DESCRIPTION	UMRP
F6PGR304S2	30"	Stainless Steel	All Gas Professional Range	\$ 5,799

Optional Accessories

MODEL	DESCRIPTION	UMRP
PDRKIT30MG	Color Door Kit, Matte Slate Gray	\$ 1,119
PDRKIT30WH	Color Door Kit, Glossy White	\$ 1,119
PDRKIT30MW	Color Door Kit, Matte White	\$ 1,119
PDRKIT30RD	Color Door Kit, Glossy Red	\$ 1,119
PDRKIT30BK	Color Door Kit, Glossy Black	\$ 1,119
PDRKIT30MB	Color Door Kit, Matte Black	\$ 1,119
NEW FMSBEZKIT06-BR	Small Bezel Kit for 30" Ranges, Venetian Brass	\$ 429
NEW FMSBEZKIT06-BZ	Small Bezel Kit for 30" Ranges, Brushed Bronze	\$ 429
NEW FMSBEZKIT06-MB	Small Bezel Kit for 30" Ranges, Matte Black	\$ 429
F6BG30ISL	30" Back Guard, Island Trim	\$ 149
F6BG30STD	30" Back Guard, Standard 3" Trim	\$ 229
F6BG30HBT	30" Back Guard, 9" Highback Trim	\$ 319
F6BG30BCI	30" Back Guard, Cast Iron Island Trim	\$ 159
FMWOK	Wok Ring	\$ 69
FMSIM	Simmer Plate	\$ 89
FMGRID30	Griddle, 30"	\$ 239
FMTRP30	Telescopic Rack, 30" Range	\$ 229
FMHAK30	High Altitude Kit, 30" Range	\$ 59

SOFIA FREESTANDING RANGES - ALL GAS

F6PGR366S2 / F6PGR364GS2

36" All Gas Professional Range

Series: 600

AVAILABLE IN 7 FINISHES



SOFA
Professional 600
Freestanding

RANGES

Cooking Surface

- 3 Heavy Duty, Continuous Cast Iron Grates -OR- 2 Heavy Duty, Continuous Cast Iron Grates with Trilaminate Stainless Steel Griddle w/ Tubular Burner
- One Piece Matte Finish Porcelain Burner Bowl
- 4-6 Dual-Flame Crescendo Burners
- 2 Burners Provide Maximum 20,000 BTUs of Power
- 2-4 Burners Provide Maximum 18,000 BTUs of Power
- Simmer Setting adjustable to 375 BTUs
- Standard Natural Gas, LP Conversion Kit Included
- Cast Iron Island Trim

Oven

- Dual Convection
- Nova Broiler System
- Black Porcelain Enamel Interior
- Cool to Touch, Soft Closing Door
- Extra Large Baking Cavity
- 3 Halogen Lights for Flawless Visibility
- Glow Plug Ignition
- 5.7 cu. ft. Capacity
- 2 Chrome Racks
- 1 Telescopic Rack
- Enameled Broiler Pan
- Complimentary Personalized Nameplate
- Oven Temperature Electronic Control
- "Sabbath Mode"



Glossy White



Glossy Black



Slate Gray



Glossy Red



Matte Black



Matte White

Product Information

MODEL	WIDTH	FINISH	DESCRIPTION	UMRP
F6PGR366S2	36"	Stainless Steel	All Gas Professional Range	\$ 6,999
F6PGR364GS2	36"	Stainless Steel	All Gas Professional Range with Griddle	\$ 7,799

Optional Accessories

MODEL	DESCRIPTION	UMRP
PDRKIT36MG	Color Door Kit, Matte Slate Gray	\$ 1,229
PDRKIT36WH	Color Door Kit, Glossy White	\$ 1,229
PDRKIT36MW	Color Door Kit, Matte White	\$ 1,229
PDRKIT36RD	Color Door Kit, Glossy Red	\$ 1,229
PDRKIT36BK	Color Door Kit, Glossy Black	\$ 1,229
PDRKIT36MB	Color Door Kit, Matte Black	\$ 1,229
NEW FMSBEZKIT11-BR	Large Bezel Kit for 36" Ranges, Venetian Brass	\$ 539
NEW FMSBEZKIT11-BZ	Large Bezel Kit for 36" Ranges, Brushed Bronze	\$ 539
NEW FMSBEZKIT11-MB	Large Bezel Kit for 36" Ranges, Matte Black	\$ 539
F6BG36ISL	36" Back Guard, Island Trim	\$ 159
F6BG36STD	36" Back Guard, Standard 3" Trim	\$ 219
F6BG36HBT	36" Back Guard, 9" Highback Trim	\$ 359
F6BG36BCI	36" Back Guard, Cast Iron Island Trim	\$ 139
FMWOK	Wok Ring	\$ 69
FMSIM	Simmer Plate	\$ 89
FMGRID36	Griddle, 36"	\$ 219
FMTRP36	Telescopic Rack, 36" Range	\$ 249
FMHAK36	High Altitude Kit, 36" Range	\$ 59

SOFIA Professional 600

Freestanding



Glossy White Glossy Black Slate Gray Glossy Red Matte Black Matte White

SOFIA FREESTANDING RANGES - ALL GAS

F6PGR486GS2

48" All Gas Professional Range
Series: 600
AVAILABLE IN 7 FINISHES



Cooking Surface

- 3 Heavy Duty, Continuous Cast Iron Grates
- Trilaminar Stainless Steel Griddle with Tubular Gas Burner
- Griddle Performs at 11,500 BTUs on High and 2,000 BTUs on Low
- One Piece, Matte Finish Porcelain Burner Bowl
- 6 Dual-Flame Crescendo Burners
- 2 Burners Provide Maximum 20,000 BTUs of Power
- 4 Burners Provide Maximum 18,000 BTUs of Power
- Simmer Setting adjustable to 375 BTUs
- Standard Natural Gas, LP Conversion Kit Included
- Cast Iron Island Trim

Oven

- Dual Convection in Main Oven
- Nova Broiler System
- Single Convection in Accessory Oven
- Black Porcelain Enamel Interior
- Cool to Touch, Soft-Closing Door
- Extra Large Baking Cavity
- Glow Plug Ignition
- 3 Halogen Lights on Main Oven
- 2 Halogen Lights on Accessory Oven
- 4.4 CuFt on Main Oven, 2.7 CuFt on Accessory Oven
- 2 Chrome Racks / 1 Telescopic Rack per oven
- Complimentary Personalized Nameplate
- "Sabbath Mode"

Product Information

MODEL	WIDTH	FINISH	DESCRIPTION	UMRP
F6PGR486GS2	48"	Stainless Steel	All Gas Professional Range	\$ 11,299

Optional Accessories

MODEL	DESCRIPTION	UMRP
PDRKIT48MG	Color Two Door Kit, Matte Slate Gray	\$ 1,919
PDRKIT48WH	Color Two Door Kit, Glossy White	\$ 1,919
PDRKIT48MW	Color Two Door Kit, Matte White	\$ 1,919
PDRKIT48RD	Color Two Door Kit, Glossy Red	\$ 1,919
PDRKIT48BK	Color Two Door Kit, Glossy Black	\$ 1,919
PDRKIT48MB	Color Two Door Kit, Matte Black	\$ 1,919
NEW FMSBEZKIT11-BR	Large Bezel Kit for 48" Ranges, Venetian Brass	\$ 539
NEW FMSBEZKIT11-BZ	Large Bezel Kit for 48" Ranges, Brushed Bronze	\$ 539
NEW FMSBEZKIT11-MB	Large Bezel Kit for 48" Ranges, Matte Black	\$ 539
F6BG48STD	48" Back Guard, Standard 3" Trim	\$ 239
F6BG48HBT	48" Back Guard, 9" Highback Trim	\$ 409
F6BG48BCI	48" Back Guard, Cast Iron Island Trim	\$ 229
FMWOK	Wok Ring	\$ 69
FMSIM	Simmer Plate	\$ 89
FMTRP30	Telescopic Rack, 30" Main Oven	\$ 229
FMTRP18	Telescopic Rack, 18" Accessory Oven	\$ 219
FMHAK48	High Altitude Kit, 48" Range	\$ 69

SOFIA FREESTANDING RANGES - INDUCTION

F6PIR304S1

30" Induction Professional Range
Series: 600
AVAILABLE IN 7 FINISHES



SOFIA
Professional 600
Freestanding

RANGES

Cooking Surface

- 4 Single Induction Cooking Zones
- Elegant Ceramic Glass Surface
- Premium Induction Technology for Unsurpassed Performance
- Booster Function for Each Cooking Zone
- Residual Heat and Power-On Indicators
- Melting and Simmering Functions
- Pot Detection
- Child Lock Function
- Knob Controlled
- Digital Display Timer
- Stainless Steel Island Trim

Oven

- Dual True Convection
- Self-Cleaning Oven with Multifunction Baking
- Black Porcelain Enamel Interior
- Cool to Touch, Soft-Closing Door
- Extra Large Baking Cavity
- 3 Halogen Lights for Flawless Visibility
- 4.4 cu. ft. Capacity
- 2 Chrome Racks
- 1 Telescopic Rack
- Enameled Broiler Pan
- Meat Probe
- Complimentary Personalized Nameplate
- "Sabbath Mode"



Product Information

MODEL	WIDTH	FINISH	DESCRIPTION	UMRP
F6PIR304S1	30"	Stainless Steel	Induction Professional Range	\$ 6,999

Optional Accessories

MODEL	DESCRIPTION	UMRP
PDRKIT30MG	Color Door Kit, Matte Slate Gray	\$ 1,119
PDRKIT30WH	Color Door Kit, Glossy White	\$ 1,119
PDRKIT30MW	Color Door Kit, Matte White	\$ 1,119
PDRKIT30RD	Color Door Kit, Glossy Red	\$ 1,119
PDRKIT30BK	Color Door Kit, Glossy Black	\$ 1,119
PDRKIT30MB	Color Door Kit, Matte Black	\$ 1,119
NEW FMSBEZKIT06-BR	Small Bezel Kit for 30" Ranges, Venetian Brass	\$ 429
NEW FMSBEZKIT06-BZ	Small Bezel Kit for 30" Ranges, Brushed Bronze	\$ 429
NEW FMSBEZKIT06-MB	Small Bezel Kit for 30" Ranges, Matte Black	\$ 429
F6BG30STD	Back Guard, 30", 3" Standard Trim*	\$ 209
F6BG30HBT	Back Guard, 30", 9" High Back Trim*	\$ 299
FMTRP30	Telescopic Rack, 30" Sofia Range	\$ 229

*Range includes a Stainless Steel island trim.

SOFIA Professional 600

Freestanding



SOFIA FREESTANDING RANGES - INDUCTION

F6PIR365S1

36" Induction Professional Range 
 Series: 600
 AVAILABLE IN 7 FINISHES

Cooking Surface

- 4 Single Induction Cooking Zones
- 1 Dual Max Power 11" Cooking Zone
- Elegant Ceramic Glass Surface
- Premium Induction Technology for Unsurpassed Performance
- Booster Function for Each Cooking Zone
- Residual Heat and Power-On Indicators
- Melting and Simmering Functions
- Pot Detection
- Child Lock Function
- Knob Controlled
- Digital Display Timer
- Stainless Steel Island Trim

Oven

- Dual True Convection
- Self-Cleaning Oven with Multifunction Baking
- Black Porcelain Enamel Interior
- Cool to Touch, Soft-Closing Door
- Extra Large Baking Cavity
- 3 Halogen Lights for Flawless Visibility
- 5.7 cu. ft. Capacity
- 2 Chrome Racks
- 1 Telescopic Rack
- Enameled Broiler Pan
- Meat Probe
- Complimentary Personalized Nameplate
- "Sabbath Mode"

Product Information

MODEL	WIDTH	FINISH	DESCRIPTION	UMRP
F6PIR365S1	36"	Stainless Steel	Induction Professional Range	\$ 9,499

Optional Accessories

MODEL	DESCRIPTION	UMRP
PDRKIT36MG	Color Door Kit, Matte Slate Gray	\$ 1,229
PDRKIT36WH	Color Door Kit, Glossy White	\$ 1,229
PDRKIT36MW	Color Door Kit, Matte White	\$ 1,229
PDRKIT36RD	Color Door Kit, Glossy Red	\$ 1,229
PDRKIT36BK	Color Door Kit, Glossy Black	\$ 1,229
PDRKIT36MB	Color Door Kit, Matte Black	\$ 1,229
NEW FMSBEZKIT11-BR	Large Bezel Kit for 36" Ranges, Venetian Brass	\$ 539
NEW FMSBEZKIT11-BZ	Large Bezel Kit for 36" Ranges, Brushed Bronze	\$ 539
NEW FMSBEZKIT11-MB	Large Bezel Kit for 36" Ranges, Matte Black	\$ 539
F6BG36STD	Back Guard, 36", 3" Standard Trim*	\$ 199
F6BG36HBT	Back Guard, 36", 9" High Back Trim*	\$ 329
FMTRP36	Telescopic Rack, 36" Sofia Range	\$ 249

*Range includes a Stainless Steel island trim.

SOFIA Professional 600

Freestanding



SOFIA FREESTANDING RANGES - INDUCTION

F6PIR487S1 / F6PIR485GS1

48" Induction Professional Range
Series: 600
AVAILABLE IN 7 FINISHES



RANGES

Cooking Surface

- 4 Single Induction Cooking Zones
- 1 Dual Max Power 11" Cooking Zone
- Elegant Ceramic Glass Surface
- 2 Bridge Zone Elements (griddle function or Built-In Griddle)
- Booster Function for Each Cooking Zone
- Residual Heat and Power-On Indicators
- Melting and Simmering Functions
- Pot Detection
- Child Lock Function
- Knob Controlled
- Digital Display Timer
- Stainless Steel Island Trim

Oven

- Dual True Convection in Main Oven
- True Convection in Accessory Oven
- Self-Cleaning Ovens with Multifunction Baking
- Black Porcelain Enamel Interior
- Cool to Touch, Soft-Closing Door
- Extra Large Baking Cavity
- 3 Halogen Lights on Main Oven
- 1 Halogen Light on Accessory Oven
- 4.4 CuFt on Main Oven, 2.7 CuFt on Accessory Oven
- 2 Chrome Racks / 1 Telescopic Rack Per Oven
- Meat Probe (Main Oven)
- Complimentary Personalized Nameplate
- "Sabbath Mode"

Product Information

MODEL	WIDTH	FINISH	DESCRIPTION	UMRP
F6PIR487S1	48"	Stainless Steel	Induction Professional Range	\$ 14,499
F6PIR485GS1	48"	Stainless Steel	Induction Professional Range With Built-in Griddle	\$ 15,499

Optional Accessories

MODEL	DESCRIPTION	UMRP
PDRKIT48MG	Color Two Door Kit, Matte Slate Gray	\$ 1,919
PDRKIT48WH	Color Two Door Kit, Glossy White	\$ 1,919
PDRKIT48MW	Color Two Door Kit, Matte White	\$ 1,919
PDRKIT48RD	Color Two Door Kit, Glossy Red	\$ 1,919
PDRKIT48BK	Color Two Door Kit, Glossy Black	\$ 1,919
PDRKIT48MB	Color Two Door Kit, Matte Black	\$ 1,919
NEW FMSBEZKIT11-BR	Large Bezel Kit for 48" Ranges, Venetian Brass	\$ 539
NEW FMSBEZKIT11-BZ	Large Bezel Kit for 48" Ranges, Brushed Bronze	\$ 539
NEW FMSBEZKIT11-MB	Large Bezel Kit for 48" Ranges, Matte Black	\$ 539
F6BG48STD	Back Guard, 48", 3" Stainless Steel Trim*	\$ 219
F6BG48BCI	Back Guard, 48", Standard Cast Iron Island Trim*	\$ 209
F6BG48HBT	Back Guard, 48", 9" High Back Trim*	\$ 379
FMTRP30	Telescopic Rack, 30" Main Oven	\$ 229
FMTRP18	Telescopic Rack, 18" Accessory Oven	\$ 219

ACCENTO Professional 400

Freestanding



ACCENTO FREESTANDING RANGES - DUAL FUEL

F4PDF304S1

30" Dual Fuel Professional Range

Series: 400

AVAILABLE IN 4 FINISHES



Cooking Surface

- 2 Heavy Duty, Continuous Cast Iron Grates
- One Piece Matte Finish Porcelain Burner Bowl
- 2 Dual-Flame 18,000 BTUs Crescendo Burners
- 2 15,000 BTUs Rapid Burners
- Standard Natural Gas, LP Conversion Kit Included
- Simmer Setting Adjustable to 375 BTUs
- Cast Iron Island Trim

Oven

- Dual True Convection
- Self Cleaning Oven with Multifunctioning Baking
- Black Porcelain Enamel Interior
- Cool to Touch Door
- Extra Large Baking Cavity
- 3 Halogen Lights for Flawless Visibility
- 4.4 cu. ft. Capacity
- 2 Chrome Racks
- Enameled Broiler Pan



Matte White

Glossy Red

Matte Black

Product Information

MODEL	WIDTH	FINISH	DESCRIPTION	UMRP
F4PDF304S1	30"	Stainless Steel	Dual Fuel Professional Range	\$ 4,549

Optional Accessories

MODEL	DESCRIPTION	UMRP
ACDKIT30MW	30" Accento Color Door Kit, Matte White	\$ 879
ACDKIT30RD	30" Accento Color Door Kit, Glossy Red	\$ 879
ACDKIT30MB	30" Accento Color Door Kit, Matte Black	\$ 879
F6BG30ISL	30" Back Guard, Island Trim	\$ 149
F6BG30STD	30" Back Guard, Standard 3" Trim	\$ 229
F6BG30HBT	30" Back Guard, 9" Highback Trim	\$ 319
F6BG30BCI	30" Back Guard, Cast Iron Island Trim	\$ 159
FMWOK	Wok Ring (For use with dual burner only)	\$ 69
FMSIM	Simmer Plate	\$ 89
FMGRID30	Griddle, 30"	\$ 239
FMTRP30	Telescopic Rack, 30" Range	\$ 229
FMHAK30	High Altitude Kit, 30" Range	\$ 59

*Range includes a cast iron island trim.

ACCENTO FREESTANDING RANGES - DUAL FUEL

ACCENTO Professional 400 Freestanding 400



F4PDF366S1

36" Dual Fuel Professional Range
Series: 400
AVAILABLE IN 4 FINISHES



Cooking Surface

- 3 Heavy Duty, Continuous Cast Iron Grates
- One Piece Matte Finish Porcelain Burner Bowl
- 3 Dual-Flame 18,000 BTUs Crescendo Burners
- 3 15,000 BTUs Rapid Burners
- Standard Natural Gas, LP Conversion Kit Included
- Simmer Setting Adjustable to 375 BTUs
- Cast Iron Island Trim

Oven

- Dual True Convection
- Self Cleaning Oven with Multifunctioning Baking
- Black Porcelain Enamel Interior
- Cool to Touch Door
- Extra Large Baking Cavity
- 3 Halogen Lights for Flawless Visibility
- 5.7 cu. ft. Capacity
- 2 Chrome Racks
- Enameled Broiler Pan



Product Information

MODEL	WIDTH	FINISH	DESCRIPTION	UMRP
F4PDF366S1	36"	Stainless Steel	Dual Fuel Professional Range	\$ 5,399

Optional Accessories

MODEL	DESCRIPTION	UMRP
ACDKIT36MW	36" Accento Color Door Kit, Matte White	\$ 1,049
ACDKIT36RD	36" Accento Color Door Kit, Glossy Red	\$ 1,049
ACDKIT36MB	36" Accento Color Door Kit, Matte Black	\$ 1,049
F6BG36ISL	36" Back Guard, Island Trim	\$ 159
F6BG36STD	36" Back Guard, Standard 3" Trim	\$ 219
F6BG36HBT	36" Back Guard, 9" Highback Trim	\$ 359
F6BG36BCI	36" Back Guard, Cast Iron Island Trim	\$ 139
FMWOK	Wok Ring (For use with dual burner only)	\$ 69
FMSIM	Simmer Plate	\$ 89
FMGRID36	Griddle, 36"	\$ 219
FMTRP36	Telescopic Rack, 36" Range	\$ 249
FMHAK36	High Altitude Kit, 36" Range	\$ 59

*Range includes a cast iron island trim.

ACCENTO Professional 400

Freestanding



ACCENTO FREESTANDING RANGES - ALL GAS

F4PGR304S2

30" All Gas Professional Range

Series: 400

AVAILABLE IN 4 FINISHES



Cooking Surface

- 2 Heavy Duty, Continuous Cast Iron Grates
- One Piece Matte Finish Porcelain Burner Bowl
- 2 Dual-Flame 18,000 BTUs Crescendo Burners
- 2 15,000 BTUs Rapid Burners
- Standard Natural Gas, LP Conversion Kit Included
- Simmer Setting Adjustable to 375 BTUs
- Cast Iron Island Trim

Oven

- Silent Glow Plug Oven Ignition
- Dual Convection
- Black Porcelain Enamel Interior
- Cool to Touch Door
- Extra Large Baking Cavity
- 3 Halogen Lights for Flawless Visibility
- 4.4 cu. ft. Capacity
- 2 Chrome Racks
- Enameled Broiler Pan



Matte White

Glossy Red

Matte Black

Product Information

MODEL	WIDTH	FINISH	DESCRIPTION	UMRP
F4PGR304S2	30"	Stainless Steel	All Gas Professional Range	\$ 4,449

Optional Accessories

MODEL	DESCRIPTION	UMRP
ACDKIT30MW	30" Accento Color Door Kit, Matte White	\$ 939
ACDKIT30RD	30" Accento Color Door Kit, Glossy Red	\$ 939
ACDKIT30MB	30" Accento Color Door Kit, Matte Black	\$ 939
F6BG30ISL	30" Back Guard, Island Trim	\$ 149
F6BG30STD	30" Back Guard, Standard 3" Trim	\$ 229
F6BG30HBT	30" Back Guard, 9" Highback Trim	\$ 319
F6BG30BCI	30" Back Guard, Cast Iron Island Trim	\$ 159
FMWOK	Wok Ring (For use with dual burner only)	\$ 69
FMSIM	Simmer Plate	\$ 89
FMGRID30	Griddle, 30"	\$ 239
FMTRP30	Telescopic Rack, 30" Range	\$ 229
FMHAK30	High Altitude Kit, 30" Range	\$ 59

*Range includes a cast iron island trim.

ACCENTO FREESTANDING RANGES - ALL GAS

ACCENTO Professional 400 Freestanding



F4PGR366S2

36" All Gas Professional Range

Series: 400

AVAILABLE IN 4 FINISHES



Cooking Surface

- 3 Heavy Duty, Continuous Cast Iron Grates
- One Piece Matte Finish Porcelain Burner Bowl
- 3 Dual-Flame 18,000 BTUs Crescendo Burners
- 3 15,000 BTUs Rapid Burners
- Standard Natural Gas, LP Conversion Kit Included
- Simmer Setting Adjustable to 375 BTUs
- Cast Iron Island Trim

Oven

- Silent Glow Plug Oven Ignition
- Dual Convection
- Black Porcelain Enamel Interior
- Cool to Touch Door
- Extra Large Baking Cavity
- 3 Halogen Lights for Flawless Visibility
- 5.7 cu. ft. Capacity
- 2 Chrome Racks
- Enameled Broiler Pan



Matte White

Glossy Red

Matte Black

Product Information

MODEL	WIDTH	FINISH	DESCRIPTION	UMRP
F4PGR366S2	36"	Stainless Steel	All Gas Professional Range	\$ 5,249

Optional Accessories

MODEL	DESCRIPTION	UMRP
ACDKIT36MW	36" Accento Color Door Kit, Matte White	\$ 1,049
ACDKIT36RD	36" Accento Color Door Kit, Glossy Red	\$ 1,049
ACDKIT36MB	36" Accento Color Door Kit, Matte Black	\$ 1,049
F6BG36ISL	36" Back Guard, Island Trim	\$ 159
F6BG36STD	36" Back Guard, Standard 3" Trim	\$ 219
F6BG36HBT	36" Back Guard, 9" Highback Trim	\$ 359
F6BG36BCI	36" Back Guard, Cast Iron Island Trim	\$ 139
FMWOK	Wok Ring (For use with dual burner only)	\$ 69
FMSIM	Simmer Plate	\$ 89
FMGRID36	Griddle, 36"	\$ 219
FMTRP36	Telescopic Rack, 36" Range	\$ 249
FMHAK36	High Altitude Kit, 36" Range	\$ 59

*Range includes a cast iron island trim.



RANGETOPS

SOFIA

Professional 600
Rangetops

F6GRT304S1

30" Gas Professional Rangetop
Series: 600



Features

- 2 Heavy Duty, Continuous Cast Iron Grates
- One Piece, Matte Finish Porcelain Burner Bowl
- 4 Dual-Flame Crescendo Burners
- 1 Burner Provides Maximum 20,000 BTUs of Power
- 3 Burners Provide Maximum 18,000 BTUs of Power
- Simmer Setting adjustable to 375 BTUs
- Standard Natural Gas, LP Conversion Kit Included
- Electronic Re-Ignition System
- Flame-out Sensor
- Top Mount Injector
- Cast Iron Island Trim

Product Information

MODEL	WIDTH	FINISH	DESCRIPTION	UMRP
F6GRT304S1	30"	Stainless Steel	All Gas Professional Rangetop	\$ 2,999

Optional Accessories

MODEL	DESCRIPTION	UMRP
F6BG30ISL	30" Back Guard, Island Trim	\$ 149
F6BG30STD	30" Back Guard, Standard 3" Trim	\$ 229
F6BG30HBT	30" Back Guard, 9" Highback Trim	\$ 319
F6BG30BCI	30" Back Guard, Cast Iron Island Trim	\$ 159
NEW FMSBEZKIT06-BR	Small Bezel Kit for 30" Rangetops, Venetian Brass	\$ 429
NEW FMSBEZKIT06-BZ	Small Bezel Kit for 30" Rangetops, Brushed Bronze	\$ 429
NEW FMSBEZKIT06-MB	Small Bezel Kit for 30" Rangetops, Matte Black	\$ 429
FMWOK	Wok Ring	\$ 69
FMSIM	Simmer Plate	\$ 89
FMGRID30	Griddle, 30"	\$ 239

SOFIA RANGETOPS - GAS

RANGE TOPS

SOFIA
Professional 600
Rangetops

F6GRT366S1 / F6GRT364GS1

36" Gas Professional Rangetop
Series: 600



Features

- 3 Heavy Duty, Continuous Cast Iron Grates -OR- 2 Heavy Duty, Continuous Cast Iron Grates with Trilaminate Stainless Steel Griddle w/ Tubular Burner
- One Piece Matte Finish Porcelain Burner Bowl
- 4-6 Dual-Flame Crescendo Burners
- 2 Burners Provide Maximum 20,000 BTUs of Power
- 2-4 Burners Provide Maximum 18,000 BTUs of Power
- Simmer Setting adjustable to 375 BTUs
- Standard Natural Gas, LP Conversion Kit Included
- Cast Iron Island Trim

Product Information

MODEL	WIDTH	FINISH	DESCRIPTION	UMRP
F6GRT366S1	36"	Stainless Steel	All Gas Professional Rangetop	\$ 3,599
F6GRT364GS1	36"	Stainless Steel	All Gas Professional Rangetop With Built-In Griddle	\$ 4,699

Optional Accessories

MODEL	DESCRIPTION	UMRP
F6BG36ISL	36" Back Guard, Island Trim	\$ 159
F6BG36STD	36" Back Guard, Standard 3" Trim	\$ 219
F6BG36HBT	36" Back Guard, 9" Highback Trim	\$ 359
F6BG36BCI	36" Back Guard, Cast Iron Island Trim	\$ 139
NEW FMSBEZKIT11-BR	Small Bezel Kit for 36" Rangetops, Venetian Brass	\$ 429
NEW FMSBEZKIT11-BZ	Small Bezel Kit for 36" Rangetops, Brushed Bronze	\$ 429
NEW FMSBEZKIT11-MB	Small Bezel Kit for 36" Rangetops, Matte Black	\$ 429
FMWOK	Wok Ring	\$ 69
FMSIM	Simmer Plate	\$ 89
FMGRID36	Griddle, 36"	\$ 219

SOFIA RANGETOPS - GAS

SOFIA
Professional 600
Rangetops

F6GRT486GS1

48" Gas Professional Rangetop
Series: 600



RANGE TOPS



Features

- 3 Heavy Duty, Continuous Cast Iron Grates
- Trilaminar Stainless Steel Griddle with Tubular Gas Burner
- Griddle Performs at 11,500 BTUs on High and 2,000 BTUs on Lows
- One Piece Matte Finish Porcelain Burner Bowl
- 6 Dual-Flame Crescendo Burners
- 2 Burners Provide Maximum 20,000 BTUs of Power
- 4 Burners Provide Maximum 18,000 BTUs of Power
- Simmer Setting Adjustable to 375 BTUs
- Standard Natural Gas, LP Conversion Kit Included
- Electronic Re-Ignition System
- Flame-Out Sensor
- Top Mount Injectors
- Cast Iron Island Trim

Product Information

MODEL	WIDTH	FINISH	DESCRIPTION	UMRP
F6GRT486GS1	48"	Stainless Steel	All Gas Professional Rangetop	\$ 5,599

Optional Accessories

MODEL	DESCRIPTION	UMRP
F6BG48STD	Back Guard, 48", 3" Stainless Steel Trim*	\$ 219
F6BG30STD	Back Guard, 30", 3" Standard Trim*	\$ 229
F6BG48BCI	Back Guard, 48", Standard Cast Iron Island Trim*	\$ 209
F6BG48HBT	Back Guard, 48", 9" High Back Trim*	\$ 379
NEW FMSBEZKIT11-BR	Large Bezel Kit for 48" Rangetops, Venetian Brass	\$ 539
NEW FMSBEZKIT11-BZ	Large Bezel Kit for 48" Rangetops, Brushed Bronze	\$ 539
NEW FMSBEZKIT11-MB	Large Bezel Kit for 48" Rangetops, Matte Black	\$ 539
FMWOK	Wok Ring	\$ 69
FMSIM	Simmer Plate	\$ 89

SOFIA Professional 600 Rangetops

F6IRT304S1

30" Professional Induction Rangetop
Series: 600



RANGE TOPS



Features

- 4 Single Induction Cooking Zones
- Elegant Ceramic Glass Surface
- Premium Induction Technology for Unsurpassed Performance
- Boost Function for Each Cooking Zone
- Automatic Heat-Up Time
- Residual Heat and Power On Indicators
- Melting and Simmering Functions
- Pot Detection System
- Child Lock Function
- Digital Power Level Display
- Stainless Steel Island Trim
- Knob Controlled

Product Information

MODEL	WIDTH	FINISH	DESCRIPTION	UMRP
F6IRT304S1	30"	Stainless Steel	Induction Professional Rangetop	\$ 3,499

Optional Accessories

MODEL	DESCRIPTION	UMRP
F6BG30STD	Back Guard, 30", 3" Standard Trim*	\$ 209
F6BG30BCI	Back Guard, 30", Cast Iron Island Trim*	\$ 149
F6BG30HBT	Back Guard, 30", 9" High Back Trim*	\$ 299
NEW FMSBEZKIT06-BR	Small Bezel Kit for 30" Rangetops, Venetian Brass	\$ 429
NEW FMSBEZKIT06-BZ	Small Bezel Kit for 30" Rangetops, Brushed Bronze	\$ 429
NEW FMSBEZKIT06-MB	Small Bezel Kit for 30" Rangetops, Matte Black	\$ 429

*Rangetop includes a stainless steel island trim.

SOFIA RANGETOPS - INDUCTION

SOFIA
Professional 600
Rangetops

F6IRT365S1

36" Professional Induction Rangetop
Series: 600



RANGE TOPS



Features

- 4 Single Induction Cooking Zones
- 1 Dual Max Power with 11" Cooking Zone
- Elegant Ceramic Glass Surface
- Premium Induction Technology for Unsurpassed Performance
- Boost Function for Each Cooking Zone
- Automatic Heat-Up Time
- Residual Heat and Power On Indicators
- Melting and Simmering Functions
- Pot Detection System
- Child Lock Function
- Digital Power Level Display
- Stainless Steel Island Trim
- Knob Controlled

Product Information

MODEL	WIDTH	FINISH	DESCRIPTION	UMRP
F6IRT365S1	36"	Stainless Steel	Induction Professional Rangetop	\$ 4,799

Optional Accessories

MODEL	DESCRIPTION	UMRP
F6BG36STD	Back Guard, 36", 3" Standard Stainless Steel Trim*	\$ 199
F6BG36BCI	Back Guard, 36", Cast Iron Trim*	\$ 129
F6BG36HBT	Back Guard, 36", 9" High Back Trim*	\$ 329
NEW FMSBEZKIT11-BR	Small Bezel Kit for 36" Rangetops, Venetian Brass	\$ 429
NEW FMSBEZKIT11-BZ	Small Bezel Kit for 36" Rangetops, Brushed Bronze	\$ 429
NEW FMSBEZKIT11-MB	Small Bezel Kit for 36" Rangetops, Matte Black	\$ 429

* Range includes a Stainless Steel island trim.

SOFIA Professional 600

Rangetops

F6IRT487S1 / F6IRT485GS1
 48" Professional Induction Rangetop
 Series: 600



NEW



NEW



Features

- 4 Single Induction Cooking Zones
- 1 Dual Max Power 11" Cooking Zone
- Elegant Ceramic Glass Surface
- 2 Bridge Zone Elements (griddle function or Built-In Griddle)
- Booster Function for Each Cooking Zone
- Residual Heat and Power-On Indicators
- Melting and Simmering Functions
- Pot Detection
- Child Lock Function
- Knob Controlled
- Digital Display Timer
- Stainless Steel Island Trim

Product Information

MODEL	WIDTH	FINISH	DESCRIPTION	UMRP
F6IRT487S1	48"	Stainless Steel	Induction Professional Rangetop	\$ 7,799
F6IRT485GS1	48"	Stainless Steel	Induction Professional Rangetop With Built-in Griddle	\$ 8,999

Optional Accessories

MODEL	DESCRIPTION	UMRP
F6BG48STD	Back Guard, 48", 3" Stainless Steel Trim*	\$ 219
F6BG48BCI	Back Guard, 48", Standard Cast Iron Trim*	\$ 209
F6BG48HBT	Back Guard, 48", 9" High Back Trim*	\$ 379
NEW FMSBEZKIT11-BR	Large Bezel Kit for 48" Rangetopss, Venetian Brass	\$ 539
NEW FMSBEZKIT11-BZ	Large Bezel Kit for 48" Rangetops, Brushed Bronze	\$ 539
NEW FMSBEZKIT11-MB	Large Bezel Kit for 48" Rangetops, Matte Black	\$ 539

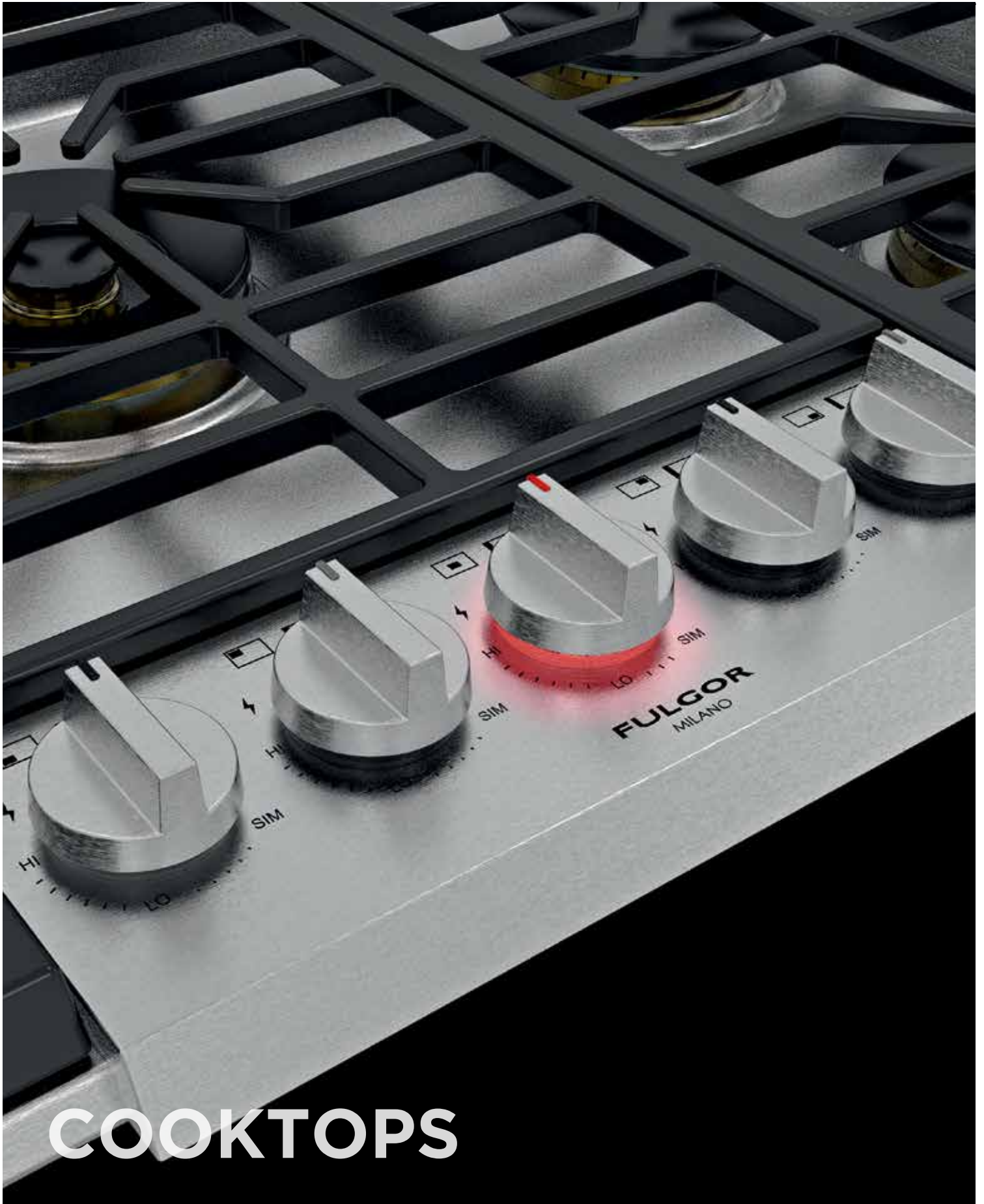

COOKTOPS

SOFIA Professional 600

Cooktops

F6PGK305S2

30" Gas Professional Cooktop
Series: 600



COOKTOPS

**Featuring
Backlit
Control Knobs
and Brass
Burners**



Features

- 3 Heavy Duty Continuous Cast Iron Grates
- Heavy Gauge 304 Stainless Steel Burner Bowl
- 1 Solid Brass Dual Flame Burner with 20,000 BTUs
- 2 Solid Brass Rapid Burners with 10,500 BTUs Each
- 2 Solid Brass Semi-Rapid Burners with 8,000 BTUs Each
- Backlit Control Knob Indicates Burner Operation (White)
- Backlit Control Knob Indicates Residual Heat (Red)
- Heavy Duty Control Panel
- Large Cooking Area
- Full Pot Stability
- Standard Natural Gas, LP Conversion Kit Included

Product Information

MODEL	WIDTH	FINISH	DESCRIPTION	UMRP
F6PGK305S2	30"	Stainless Steel	All Gas Professional Cooktop	\$ 1,899

Optional Accessories

MODEL	DESCRIPTION	UMRP
FMWOK	Wok Ring (For use with dual burner only)	\$ 69
FMSIM	Simmer Plate	\$ 89

SOFIA COOKTOPS - GAS

SOFIA
Professional 600
Cooktops

F6PGK365S2
36" Gas Professional Cooktop
Series: 600



COOKTOPS

Featuring
Backlit
Control Knobs
and Brass
Burners

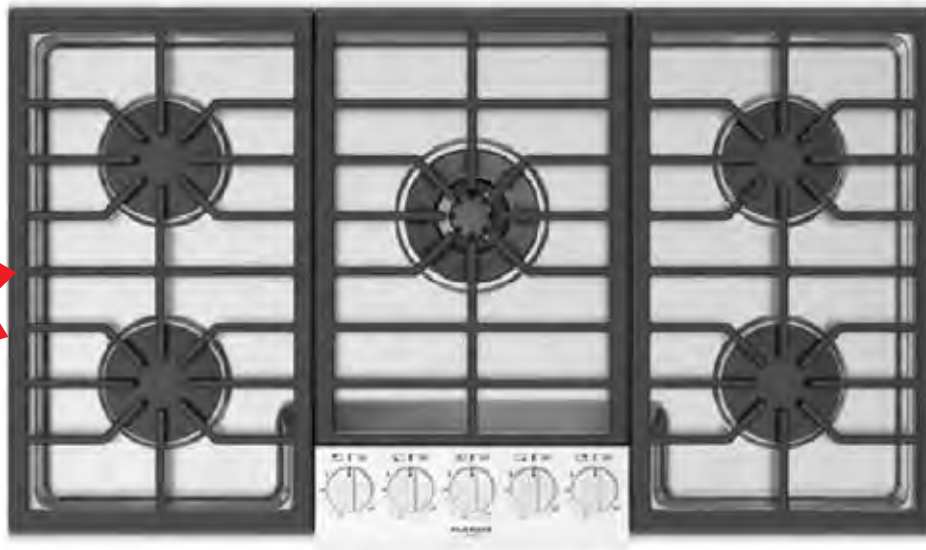

Features

- 3 Heavy Duty Continuous Cast Iron Grates
- Heavy Gauge 304 Stainless Steel Burner Bowl
- 1 Solid Brass Dual Flame Burner with 20,000 BTUs
- 4 Solid Brass Stacked Burners with 15,000 BTUs Each
- Backlit Control Knob Indicates Burner Operation (White)
- Backlit Control Knob Indicates Residual Heat (Red)
- Heavy Duty Control Panel
- Large Cooking Area
- Full Pot Stability
- Standard Natural Gas, LP Conversion Kit Included

Product Information

MODEL	WIDTH	FINISH	DESCRIPTION	UMRP
F6PGK365S2	36"	Stainless Steel	All Gas Professional Cooktop	\$ 2,249

Optional Accessories

MODEL	DESCRIPTION	UMRP
FMWOK	Wok Ring (For use with dual burner only)	\$ 69
FMSIM	Simmer Plate	\$ 89

SOFIA Professional 400

Cooktops

F4PGK305S2

30" Gas Professional Cooktop
Series: 400



Features

- 3 Heavy Duty Continuous Cast Iron Grates
- Heavy Gauge 304 Stainless Steel Burner Bowl
- 1 Aluminum Dual Flame Burner with 20,000 BTUs
- 2 Aluminum Rapid Burners with 10,500 BTUs Each
- 2 Aluminum Semi-Rapid Burners with 8,000 BTUs Each
- Heavy Duty Control Panel
- Large Cooking Area
- Full Pot Stability
- Standard Natural Gas, LP Conversion Kit Included

Product Information

MODEL	WIDTH	FINISH	DESCRIPTION	UMRP
F4PGK305S2	30"	Stainless Steel	All Gas Professional Cooktop	\$ 1,549

Optional Accessories

MODEL	DESCRIPTION	UMRP
FMWOK	Wok Ring (For use with dual burner only)	\$ 69
FMSIM	Simmer Plate	\$ 89

SOFIA COOKTOPS - GAS

SOFIA
Professional 400
Cooktops

F4PGK365S1
36" Gas Professional Cooktop
Series: 400



COOKTOPS



Features

- 3 Heavy Duty Continuous Cast Iron Grates
- Heavy Gauge 304 Stainless Steel Burner Bowl
- 1 Aluminum Dual Flame Burner with 20,000 BTUs
- 2 Aluminum Stacked Burners with 15,000 BTUs Each
- 1 Aluminum Stacked Burner with 12,000 BTUs
- 1 Aluminum Stacked Burner with 8,000 BTUs
- Heavy Duty Control Panel
- Large Cooking Area
- Full Pot Stability
- Standard Natural Gas, LP Conversion Kit Included

Product Information

MODEL	WIDTH	FINISH	DESCRIPTION	UMRP
F4PGK365S1	36"	Stainless Steel	All Gas Professional Cooktop	\$ 1,999

Optional Accessories

MODEL	DESCRIPTION	UMRP
FMWOK	Wok Ring (For use with dual burner only)	\$ 69
FMSIM	Simmer Plate	\$ 89

Series 400
Gas Cooktops

F4GK24S1
24" Gas Cooktop
Series: 400



Features

- 4 Burners with (1) 18,000 BTU Crescendo Burner
- Standard NG, LP Conversion Kit Included
- Electronic Re-Ignition System
- Flame-Out Sensor
- Heavy Duty Cast Iron Continuous Grates

Product Information

MODEL	WIDTH	FINISH	DESCRIPTION	UMRP
F4GK24S1	24"	Stainless Steel	Gas Cooktop	\$ 899

Optional Accessories

MODEL	DESCRIPTION	UMRP
FMSPR	Small Pot Insert/Reducer, Single Burner	\$ 69
FMWOK	Wok Ring (For use with dual burner only)	\$ 69
FMSIM	Simmer Plate, Single Burner	\$ 89

Series 400
Gas Cooktops

F4GK30S1
30" Gas Cooktop
Series: 400



Features

- 5 Burners with (1) 18,000 Crescendo BTU Burner
- Standard NG, LP Conversion Kit Included
- Electronic Re-Ignition System
- Flame-Out Sensor
- Heavy Duty Cast Iron Continuous Grates

Product Information

MODEL	WIDTH	FINISH	DESCRIPTION	UMRP
F4GK30S1	30"	Stainless Steel	Gas Cooktop	\$ 1,079

Optional Accessories

MODEL	DESCRIPTION	UMRP
FMSPR	Small Pot Insert/Reducer, Single Burner	\$ 69
FMWOK	Wok Ring (For use with dual burner only)	\$ 69
FMSIM	Simmer Plate, Single Burner	\$ 89

COLLECTION COOKTOPS - GAS

COOKTOPS

Series 400
Gas Cooktops

F4GK36S1
36" Gas Cooktop
Series: 400



Features

- 5 Burners with (1) 18,000 BTU Crescendo Burner
- NG, LP Conversion Kit Included
- Electronic Re-Ignition System
- Flame-Out Sensor
- Heavy Duty Cast Iron Continuous Grates

Product Information

MODEL	WIDTH	FINISH	DESCRIPTION	UMRP
F4GK36S1	36"	Stainless Steel	Gas Cooktop	\$ 1,189

Optional Accessories

MODEL	DESCRIPTION	UMRP
FMSPR	Small Pot Insert/Reducer, Single Burner	\$ 69
FMWOK	Wok Ring (For use with dual burner only)	\$ 69
FMSIM	Simmer Plate, Single Burner	\$ 89

Series 400
Gas Cooktops

F4GK42S1
44" Gas Cooktop
Series: 400



Features

- 4 Burners with (1) 18,000 BTU Crescendo Burner
- NG, LP Conversion Kit Included
- Electronic Re-Ignition System
- Flame-Out Sensor
- Heavy Duty Cast Iron Continuous Grates

Product Information

MODEL	WIDTH	FINISH	DESCRIPTION	UMRP
F4GK42S1	44"	Stainless Steel	Gas Cooktop	\$ 1,129

Optional Accessories

MODEL	DESCRIPTION	UMRP
FMSPR	Small Pot Insert/Reducer, Single Burner	\$ 69
FMWOK	Wok Ring (For use with dual burner only)	\$ 69
FMSIM	Simmer Plate, Single Burner	\$ 89

Series 700
Induction Cooktops

F7IT30S1 & F7IT36S1 ⚡
30" & 36" Induction Cooktop
Series: 700



F7IT30S1



F7IT36S1

Features

- 4 Cooking Zones - 30"
- 5 Cooking Zones - 36"
- Bridge Zone - 36"
- Easy Clean Textured Ceramic Glass Surface
- 11" Cooking Zone
- Premium Induction Technology for Unsurpassed Performance
- Independent Timer for Each Zone
- Melting and Warming Functions
- Residual Heat and Power on Indicators
- Pan and Pot Detection System
- Child Lock Function
- Booster Function for each Cooking Zone
- Digital Display for Power Level
- Elegant Aluminum Trim
- Pause Function
- Automatic Fast-Boil Function

Product Information

MODEL	WIDTH	FINISH	DESCRIPTION	UMRP
F7IT30S1	30"	Black Glass	Induction Cooktop	\$ 1,949
F7IT36S1	36"	Black Glass	Induction Cooktop	\$ 2,549

COLLECTION COOKTOPS - INDUCTION

Series 400
Induction Cooktops

F4IT24B2 & F4IT24S2
24" Induction Cooktop
Series: 400



COOKTOPS

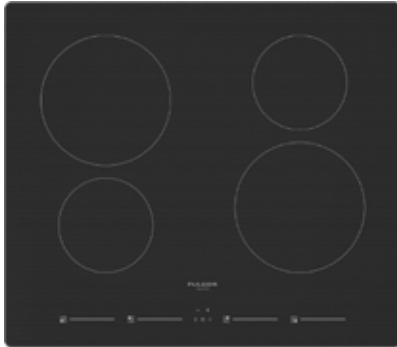

F4IT24B2

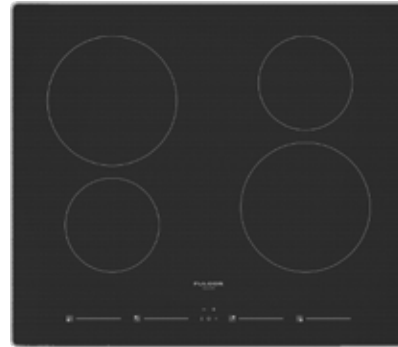

F4IT24S2

Features

- 4 Cooking Zones - 30"
- 5 Cooking Zones - 36"
- Bridge Zone - 36"
- Easy Clean Textured Ceramic Glass Surface
- 11" Cooking Zone
- Premium Induction Technology for Unsurpassed Performance
- Independent Timer for Each Zone
- Melting and Warming Functions
- Residual Heat and Power on Indicators
- Pan and Pot Detection System
- Child Lock Function
- Booster Function for each Cooking Zone
- Digital Display for Power Level
- Elegant Aluminum Trim
- Pause Function
- Automatic Fast-Boil Function

Product Information

MODEL	WIDTH	FINISH	DESCRIPTION	UMRP
F4IT24B2	24"	Black Glass	Induction Cooktop	\$ 1,279
F4IT24S2	24"	Black Glass w/ Aluminum Trim	Induction Cooktop	\$ 1,349

Series 400
Induction Cooktops

F4IT30B2 & F4IT30S2

30" Induction Cooktop
Series: 400

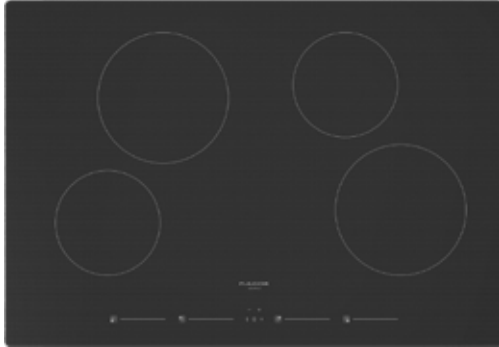

F4IT30B2



F4IT30S2

Features

- 4 Cooking Zones - 30"
- Easy Clean Textured Ceramic Glass Surface
- Built-In Timer
- Melting Functions
- Residual Heat and Power on Indicators
- Pan and Pot Detection System
- Child Lock Function
- Booster Function for each Cooking Zone
- Digital Display for Power Level
- Elegant Aluminum Trim
- Pause Function
- Automatic Fast-Boil Function

Product Information

MODEL	WIDTH	FINISH	DESCRIPTION	UMRP
F4IT30B2	30"	Black Glass	Induction Cooktop	\$ 1,379
F4IT30S2	30"	Black Glass w/ Aluminum Trim	Induction Cooktop	\$ 1,449

Series **700**
Radiant Cooktops

F7RT24 & F7RT30
24" & 30" Radiant Cooktop
Series: 700



F7RT24B1

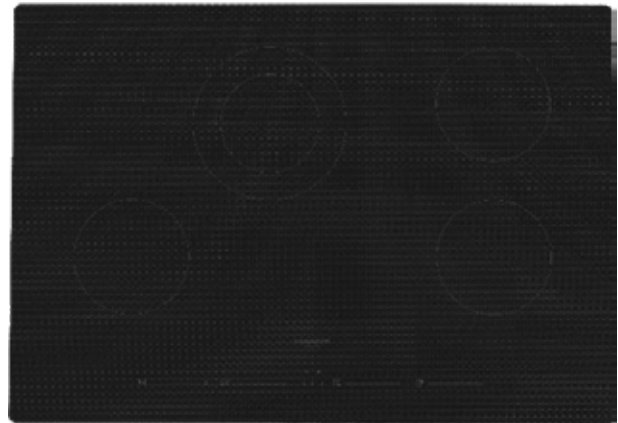

F7RT30B1

Features

- 4 Cooking Zones - 30"
- 5 Cooking Zones - 36"
- Bridge Zone - 36"
- Digital Display for Power Level
- Low Power Scale for Delicate Cooking
- Control Lock
- Automatic Fast-Boil Function
- Independent Timer for Each Zone
- Easy Clean Textured Glass Surface
- Power and Hot Surface Indication
- Timer Functions
- Timer Display
- Acoustic Buzzer
- Brushed Aluminum Trim
- Booster Function for Each Cooking Zone

Product Information

MODEL	WIDTH	FINISH	DESCRIPTION	UMRP
F7RT24B1	24"	Black Glass	Radiant Cooktop	\$ 979
F7RT24S1	24"	Black Glass w/ Aluminum Trim	Radiant Cooktop	\$ 999
F7RT30B1	30"	Black Glass	Radiant Cooktop	\$ 1,099
F7RT30S1	30"	Black Glass w/ Aluminum Trim	Radiant Cooktop	\$ 1,149

COLLECTION COOKTOPS - **RADIANT**

COOKTOPS

Series **300**
Radiant Cooktops

F3RK24S2
24" Radiant Cooktop
Series: 300



Features

- 4 Cooking Zones
- Power on Indication
- Hot Surface Indication
- Easy Clean Ceramic Glass
- Residual Heat Sensor
- Double Radiant Cooking Zone
- Brushed Aluminum Trim

Product Information

MODEL	WIDTH	FINISH	DESCRIPTION	UMRP
F3RK24S2	24"	Black Glass	Radiant Cooktop	\$ 829



Ovens

SOFIA

Professional 600

Single Oven

SOFIA BUILT-IN OVENS - SINGLE

F6PSP30S1

30" Professional Single Oven
Series: 600
Available in 7 Finishes



Features

- Knob and Electronic Controls
- Dual True Convection
- Self-Cleaning Oven with Multi-function Baking
- Black Porcelain Enamel Interior
- Cool to Touch, Soft-Closing Door
- Extra-Large Baking Cavity and Viewing Area
- 3 Halogen Lights for Flawless Visibility
- Gross Capacity 4.4 cu. ft.
- 2 Chrome Racks
- 1 Telescopic Rack
- Enameled Broiler Pan
- Complimentary Personalized Nameplate
- Perfect for Installation Under a Cooktop

Oven Functions

- Bake
- Broil
- Roast
- Sabbath Mode
- Electronic Cooking Programmer
- True Convection
- Warm / Proof / Dehydrate / Defrost
- Timer Controlled Cooking
- Meat Probe
- Self Clean
- Bake
- Convection

Product Information

MODEL	WIDTH	FINISH	DESCRIPTION	UMRP
F6PSP30S1	30"	Stainless Steel	Professional Single Oven	\$ 4,199

Optional Accessories

MODEL	DESCRIPTION	UMRP
PDRKIT30MG	Color Door Kit, Matte Slate Gray	\$ 1,119
PDRKIT30WH	Color Door Kit, Glossy White	\$ 1,119
PDRKIT30MW	Color Door Kit, Matte White	\$ 1,119
PDRKIT30RD	Color Door Kit, Glossy Red	\$ 1,119
PDRKIT30BK	Color Door Kit, Glossy Black	\$ 1,119
PDRKIT30MB	Color Door Kit, Matte Black	\$ 1,119
NEW FMSBEZKIT06-BR	Small Bezel Kit for Wall Ovens, Venetian Brass	\$ 429
NEW FMSBEZKIT06-BZ	Small Bezel Kit for Wall Ovens, Brushed Bronze	\$ 429
NEW FMSBEZKIT06-MB	Small Bezel Kit for Wall Ovens, Matte Black	\$ 429
FMTRP30	Telescopic Rack, 30"	\$ 229

Line drawing found on page 84

SOFIA BUILT-IN OVENS - DOUBLE

SOFIA Professional Double Oven 600



F6PDP30S1

30" Professional Double Oven
Series: 600
Available in 7 Finishes



OVENS

Features

- Knob and Electronic Controls
- Dual True Convection
- Self-Cleaning Oven with Multi-Function Baking
- Black Porcelain Enamel Interior
- Cool to Touch, Soft Closing Door
- Extra-Large Baking Cavity and Viewing Area
- 3 Halogen Lights for Flawless Visibility
- Gross Capacity 4.4 cu. ft. Per Oven
- 2 Chrome Racks Per Oven
- 1 Telescopic Rack Per Oven
- Enameled Broiler Pan
- Complimentary Personalized Nameplate (Bottom Oven Only)

Oven Functions

- Bake
- Broil
- Roast
- Convection
- True Convection
- Warm / Proof / Dehydrate / Defrost
- Timer Controlled Cooking
- Meat Probe (Top Oven)
- Self Clean
- Sabbath Mode
- Electronic Cooking Programmer

Product Information

MODEL	WIDTH	FINISH	DESCRIPTION	UMRP
F6PDP30S1	30"	Stainless Steel	Professional Double Oven	\$ 6,999

Optional Accessories

MODEL	DESCRIPTION	UMRP
F6PDPKIT30MG	Double Wall Oven Color Kit, 2 Doors, Matte Slate Gray	\$ 2,188
F6PDPKIT30WH	Double Wall Oven Color Kit, 2 Doors, Glossy White	\$ 2,188
F6PDPKIT30MW	Double Wall Oven Color Kit, 2 Doors, Matte White	\$ 2,188
F6PDPKIT30RD	Double Wall Oven Color Kit, 2 Doors, Glossy Red	\$ 2,188
F6PDPKIT30BK	Double Wall Oven Color Kit, 2 Doors, Glossy Black	\$ 2,188
F6PDPKIT30MB	Double Wall Oven Color Kit, 2 Doors, Matte Black	\$ 2,188
NEW FMSBEZKIT06-BR	Small Bezel Kit for Wall Ovens, Venetian Brass	\$ 429
NEW FMSBEZKIT06-BZ	Small Bezel Kit for Wall Ovens, Brushed Bronze	\$ 429
NEW FMSBEZKIT06-MB	Small Bezel Kit for Wall Ovens, Matte Black	\$ 429
FMTRP30	Telescopic Rack, 30"	\$ 229

Line drawing found on page 85



CREACTIVE

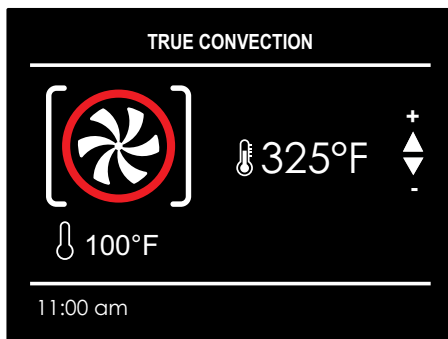

MULTI-LEVEL COOKING MODE
Internal heat remains constant throughout the oven, while smells and flavors are kept apart due to the fan assisted system.

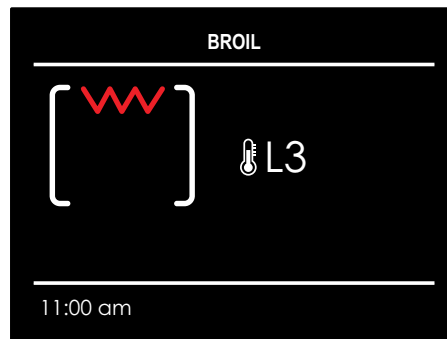

BROIL
The most effective way to brown or roast your meat in a short amount of time.

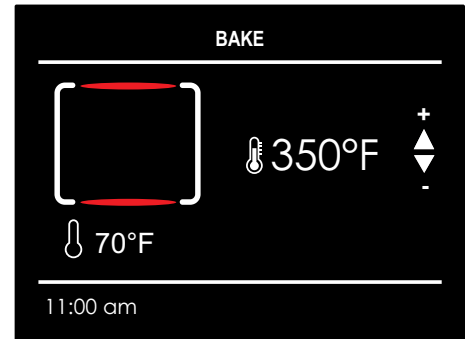

BAKE
Optimal for perfect baking: flavors blend effortlessly.

Creactive Control System

Our Creactive Control System featured on select 700 Series Built-In Wall Ovens and Specialty Ovens combines cutting edge technology with simplicity.

The touch screen simplifies all procedures and improves performance by reducing energy consumption while intensifying cooking modes. The automatic function system has safety features to warn against and prevent possible damages.

TOUCH CONTROL PANEL

Everything is under your control with just one touch on the Creactive display.

INTUITIVE

It only takes a moment to easily find the desired function.

MULTITASKING

All functions help to get the best results while preparing your recipes.



PIZZA MODE 590 °F

Two pizzas can be cooked in only two and a half minutes at the same time with a maximum temperature of 590 °F.



CUSTOMIZABLE RECIPES

Cooking times and modes have been preprogrammed, but you can modify and customize your recipes to suit every palate and need.

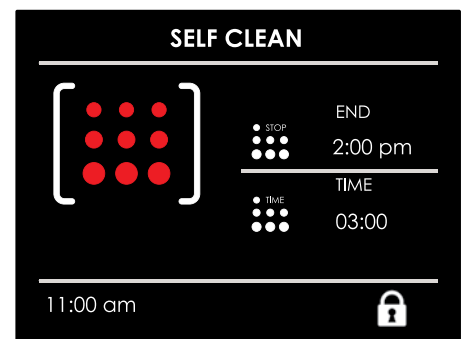

SELF-CLEANING

The pyrolytic self-clean function, selected directly from display, consists of heating the inside of the oven to very high temperatures in order to burn off any excess grease and food residue.

COLLECTION BUILT-IN OVENS - SINGLE ELECTRIC

OVENS

Series 700
Single Ovens

F7SM24S1

24" Easy Clean Single Oven
Series: 700



Features

- Touch Control System
- Easy Clean
- True Convection
- Black Porcelain Enamel Interior
- 1 Halogen Light
- Gross Capacity 2.6 CuFt
- 2 Chrome Racks
- Enameled Broiler Pan
- 1200W Broiler Element (240V)
- Perfect for Installation Under Cooktop
- Cool to Touch Door

Oven Functions

- Bake
- Broil
- Convection Bake
- Convection Broil
- Convection Roast

Product Information

MODEL	WIDTH	FINISH	DESCRIPTION	UMRP
F7SM24S1	24"	Stainless Steel	Multi-Function Wall Oven, Easy Oven	\$ 1,299

Optional Accessories

MODEL	DESCRIPTION	UMRP
FMTELG	24" Telescopic Oven Rack Guides	\$ 119

COLLECTION BUILT-IN OVENS - SINGLE ELECTRIC



Series 700
Single Ovens

F7SP24S1

24" Self Clean Single Oven
Series: 700



OVENS



Features

- Creactive Touch Control System
- Self Clean
- True Convection
- Black Porcelain Enamel Interior
- 1 Halogen Light
- Gross Capacity 2.6 CuFt
- 2 Chrome Racks
- 15 Cooking Functions
- Telescopic Rack
- Enameled Broiler Pan
- 1200W Broiler Element (240V)
- Perfect for Installation Under Cooktop
- Cool to Touch Door
- Door Safety Lock
- Fast PreHeat Mode
- Pre-Loaded Recipes that can be Customized
- Sabbath Mode

Oven Functions

- Bake
- Broil
- Convection Bake
- Convection Broil
- Convection Roast

Product Information

MODEL	WIDTH	FINISH	DESCRIPTION	UMRP
F7SP24S1	24"	Stainless Steel	Multi-Function Wall Oven, Self Oven	\$ 1,759

Optional Accessories

MODEL	DESCRIPTION	UMRP
FMTELG	24" Telescopic Oven Rack Guides	\$ 119

COLLECTION BUILT-IN OVENS - SINGLE - ELECTRIC

Series 700

Single Ovens



F7SP30

30" Touch Control Single Oven
Series: 700



Features

- Creactive Touch Control System
- Dual True Convection
- Self-Cleaning Oven with Multi-Function Baking
- Black Porcelain Enamel Interior
- Cool to Touch, Soft-Closing Door
- Extra-Large Baking Cavity and Viewing Area
- 3 Halogen Lights for Flawless Visibility
- Gross Capacity 4.4 cu. ft.
- 2 Chrome Racks
- 1 Telescopic Rack
- Enameled Broiler Pan
- Door Lock
- Perfect for Installation Under Cooktop



Finishes



Black Glass*



White Glass*



Stainless

Oven Functions

- Bake
- Broil
- Convection
- Recipes
- Classic Pizza Function 590 °F
- Preset / Last-Used
- Temperature Memory
- Automatic Fast Preheat
- Sabbath Mode
- Temperature Display °C/ °F
- Event Logs (for service)
- Meat Probe
- Self Clean
- Fast Preheat Mode
- Set Temperature and Weight
- Keep Warm

Product Information

MODEL	WIDTH	FINISH	DESCRIPTION	UMRP
F7SP30S1	30"	Stainless Steel	Single Electric Wall Oven	\$ 3,049
F7SP30B1 *	30"	Black Glass	Single Electric Wall Oven	\$ 2,699
F7SP30W1 *	30"	White Glass	Single Electric Wall Oven	\$ 2,699
FMTR630	30"		Telescopic Rack, 30"	\$ 199

* Discontinued once inventory levels are depleted

COLLECTION BUILT-IN OVENS - DOUBLE - ELECTRIC



CREACTIVE

F7DP30

30" Touch Control Double Oven
Series: 700



Features

- Creative Touch Control System
- Dual True Convection
- Self-Cleaning Oven with Multi-Function Baking
- Black Porcelain Enamel Interior
- Cool to Touch, Soft-Closing Door
- Extra-Large Baking Cavity and Viewing Area
- 3 Halogen Lights for Flawless Visibility
- Gross Capacity 4.4 cu. ft.per Oven
- 2 Chrome Racks per Oven
- 1 Telescopic Rack per Oven
- Enameled Broiler Pan
- Door Lock

Oven Functions

- Bake
- Broil
- Convection
- Recipes
- Classic Pizza Function 590 ° F
- Preset / Last-Used
- Temperature Memory
- Set Temperature and Weight
- Automatic Fast Preheat
- Sabbath Mode
- Temperature Display °C/ °F
- Event Logs (for service)
- Meat Probe for Upper Oven
- Self Clean
- Fast Preheat Mode
- Keep Warm

Finishes



Black Glass*



White Glass*



Stainless

Product Information

MODEL	WIDTH	FINISH	DESCRIPTION	UMRP
F7DP30S1	30"	Stainless Steel	Double Electric Wall Oven	\$ 5,299
F7DP30B1 *	30"	Black Glass	Double Electric Wall Oven	\$ 4,699
F7DP30W1 *	30"	White Glass	Double Electric Wall Oven	\$ 4,699
FMTR630	30"		Telescopic Rack, 30"	\$ 199

* Discontinued once inventory levels are depleted

Series 700
Double Ovens



Series 400
Single Ovens

OVENS



F4SP30S3

30" Multi-Function Self-Clean Oven ⚡
Series: 400

Features

- Knob and Electronic Controls
- Single Fan True Convection
- Self-Cleaning Oven with Multi-Function Baking
- Black Porcelain Enamel Interior
- Cool to Touch Door
- Extra-Large Baking Cavity and Viewing Area
- 3 Halogen Lights for Flawless Visibility
- Gross Capacity 4.4 cu. ft.
- 2 Chrome Racks
- Enameled Broiler Pan
- Perfect for Installation Under Cooktop

Oven Functions

- Bake
- Broil
- Thaw (Defrost)
- Self Clean
- Dehydrate
- Cooking Programmer
- Convection Bake
- Convection Broil
- Convection Roast
- Convection
- True Convection
- Sabbath Mode

Product Information

MODEL	WIDTH	FINISH	DESCRIPTION	UMRP
F4SP30S3	30"	Stainless Steel	Multi-Function Wall Oven, Self Clean	\$ 1,999

Optional Accessories

MODEL	DESCRIPTION	UMRP
FMTR630	30" Telescopic Oven Guides	\$ 199

COLLECTION BUILT-IN OVENS - SINGLE - ELECTRIC

Series 100
Single Ovens

F1SM24S2

24" Multi-Function Easy-Clean Oven
Series: 100



OVENS

Features

- Knob and Electronic Controls
- True Convection
- Black Porcelain Enamel Interior
- 1 Halogen Light
- Gross Capacity 2.6 cu. ft.
- 2 Chrome Racks
- Enameled Broiler Pan
- 1200W Broiler Element (240V)
- Perfect for Installation Under Cooktop
- LED Clock/Timer Display

Oven Functions

- Bake
- Broil
- Convection Bake
- Convection Broil
- Convection Roast
- Lower Convection Bake



Product Information

MODEL	WIDTH	FINISH	DESCRIPTION	UMRP
F1SM24S2	24"	Stainless Steel	Multi-Function Wall Oven, Easy Clean	\$ 879

Optional Accessories

MODEL	DESCRIPTION	UMRP
FMTELG	24" Telescopic Oven Rack Guides	\$ 119

Series 100
Single Ovens

F1SP30S3 & F1SM30S3
30" Multi-Function Ovens
Series: 100



OVENS



Features - F1SP30S3

- Self-Cleaning Oven with Multi-Function Baking
- Knob and Electronic Controls
- True Convection
- Black Porcelain Enamel Interior
- 2 Halogen Lights
- Gross Capacity 3.0 cu. ft.
- 2 Chrome Racks
- Enameled Broiler Pan
- 3100W Broiler Element (240V)
- LED Clock/Timer Display
- Perfect for Installation Under Cooktop
- 30" x 24" Space Saving Design

Features - F1SM30S3

- Easy Clean Oven with Multi-Functional Baking
- Knob and Electronic Controls
- True Convection
- Black Porcelain Enamel Interior
- 2 Halogen Lights
- Gross Capacity 3.0 cu. ft.
- 2 Chrome Racks
- Enameled Broiler Pan
- 3100W Broiler Element (240V)
- Perfect for Installation Under Cooktop
- LED Clock/Timer Display
- 30" x 24" Space Saving Design

Oven Functions

- Bake
- Broil
- Thaw (Defrost)
- Self Clean (Only on F1SP30S3)
- Convection Bake
- Convection Broil
- Convection Roast
- Lower Convection Bake

Product Information

MODEL	WIDTH	FINISH	DESCRIPTION	UMRP
F1SP30S3	30"	Stainless Steel	Multi-Function Wall Oven, Self Clean	\$ 1,899
F1SM30S3	30"	Stainless Steel	Multi-Function Wall Oven, Easy Clean	\$ 1,499

Optional Accessories

MODEL	DESCRIPTION	UMRP
FMTR130	30" Telescopic Oven Rack	\$ 199

SOFIA
Professional **600**
Double Oven

F6PSPD30S1
30" Combi Convection Speed Oven
Series: 600

OVENS



Features

- 3-in-1 Combi Oven (Microwave, Convection and Combination)
- 10 Cooking Functions
- Quick access menu
- Automatic programs
- Combined microwave and fan assisted mode
- 240 Volt Connection
- Microwave Mode has 6 Power Levels
- Pre-Loaded recipes that can be Customized
- Defrosting by Time and Weight
- Stainless Steel Interior
- Cool Touch Door
- Interior Lighting
- 1.2 CuFt Capacity

Included

- Meat Probe
- 1 Micro-perforated Pan with Stainless Steel Cover
- 1 Stainless Steel Tray
- 1 Flat Rack

Product Information

MODEL	WIDTH	FINISH	DESCRIPTION	UMRP
F6PSPD30S1	30"	Stainless Steel	Professional Speed Oven	\$ 3,099

Series **700**
Single Ovens

F7DSPD24S1/F7DSPD30S1

24" & 30" Combi Convection Speed Oven
Series: 700



Features

- 3-in-1 Combi Oven (Microwave, Convection or Combination)
- 10 Cooking Functions
- Quick Access Menu
- Microwave Mode includes 6 Power Levels
- Stainless Steel Interior
- Cool Touch Door
- Interior Lighting
- 1.2 CuFt Capacity
- Grill Mode
- Defrosting by Time and Weight

Included

- Meat Probe
- 1 Micro-perforated Pan with Stainless Steel Cover
- 1 Stainless Steel Tray
- 1 Flat Rack

Product Information

MODEL	WIDTH	FINISH	DESCRIPTION	UMRP
F7DSPD24S1	24"	Stainless Steel	Combi Convection Speed Oven	\$ 2,199
F7DSPD30S1	30"	Stainless Steel	Combi Convection Speed Oven	\$ 2,599

SOFIA SPECIALTY OVENS - **STEAM**

SOFIA
Professional ^{Oven} 600

F6PSCO30S1

30" Combi Convection Steam Oven

Series: 600

OVENS



Features

- 3-in-1 Combi Oven (Steam, Convection and Combi-Steam)
- 12 Cooking Functions
- Removable Water Tank
- Quick Access Menu
- 240 Volt Connection
- Pre-Loaded recipes that can be Customized
- Steam Recovery System
- Easy Steam Cleaning Cycle
- Limescale Water Filter
- Stainless Steel Interior
- Cool Touch Door
- Interior Lighting
- 1.2 CuFt Capacity

Included

- Meat Probe
- 1 Micro-perforated Pan with Stainless Steel Cover
- 1 Stainless Steel Tray
- 1 Flat Rack

Product Information

MODEL	WIDTH	FINISH	DESCRIPTION	UMRP
F6PSCO30S1	30"	Stainless Steel	Professional Steam Oven	\$ 3,449

Series 700
Single Ovens

F7DSCO30S1

24" & 30" Combi Convection Steam Oven 
Series: 700



Features

- 3-in-1 Combi Oven (Steam, Convection or Combination)
- 12 Cooking Functions
- Removable Water Tank
- Quick Access Menu
- Steam Recovery System
- Easy Steam Cleaning Cycle
- Limescale Water Filter
- Stainless Steel Interior
- Cool Touch Door
- Interior Lighting
- 1.2 CuFt Capacity

Included

- Meat Probe
- 1 Micro-perforated Pan with Stainless Steel Cover
- 1 Stainless Steel Tray
- 1 Flat Rack

Product Information

MODEL	WIDTH	FINISH	DESCRIPTION	UMRP
F7SCO24S1	24"	Stainless Steel	Combi Convection Steam Oven	\$ 2,449
F7DSCO30S1	30"	Stainless Steel	Combi Convection Steam Oven	\$ 2,849

Optional Accessories

MODEL	DESCRIPTION	UMRP
F7DTK30S0	30" Trim Kit for Combination Steam Oven	\$ 429

WARMING DRAWERS

SOPIA
Professional Warming Drawer **600**

Series 400 & 700
Warming Drawers

F6PWD30S1

30" Professional Warming Drawer ⚡
Series: 600
Available in 7 Finishes

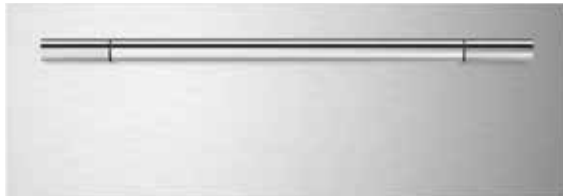

WD24 & WD30

24" & 30" Warming Drawer ⚡
Series: 400 & 700

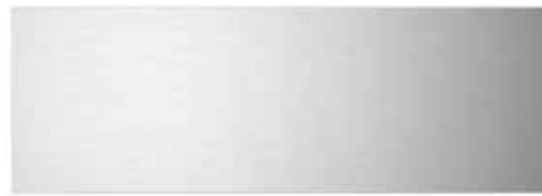

OVENS

Features

- Stainless Steel Construction
- Knob Control
- Full Extension Telescopic Rails
- Large Capacity, 2.1 CuFt (30" Models)
- Convection Heating System for Even Heat Distribution
- Warming Temperature Range - 86°F - 190°F
- Push-Pull System to Open and Close Door
- Interior Lighting
- Non-Slip Rubber Mat
- Available in Stainless Steel and Panel Ready Models (30" Models)
- Push to Open on F7IWD3001, F7DWD30S1 and F4DWD24S1

Functions

- Pre-heat Dishes
- Pre-heat Coffee Cups
- Keep Food Warm
- Defrosting Dough
- Proofing Dough
- Slow Cooking - 86°F - 190°F

Product Information

MODEL	WIDTH	Height	FINISH	DESCRIPTION	UMRP
F6PWD30S1	30"	10"	Stainless Steel	Professional Warming Drawer	\$ 1,599
F4DWD24S1	24"	6"	Stainless Steel	Warming Drawer	\$ 1,099
F7DWD30S1	30"	10"	Stainless Steel	Warming Drawer	\$ 1,399
F7IWD3001	30"	10"	Panel Ready	Warming Drawer	\$ 1,349

Optional Accessories for F6PWD30S1 Model Only

MODEL	DESCRIPTION	UMRP
PWDKIT30MG	Color Drawer Kit, Matte Slate Gray	\$ 359
PWDKIT30WH	Color Drawer Kit, Glossy White	\$ 359
PWDKIT30MW	Color Drawer Kit, Matte White	\$ 359
PWDKIT30RD	Color Drawer Kit, Glossy Red	\$ 359
PWDKIT30BK	Color Drawer Kit, Glossy Black	\$ 359
PWDKIT30MB	Color Drawer Kit, Matte Black	\$ 359

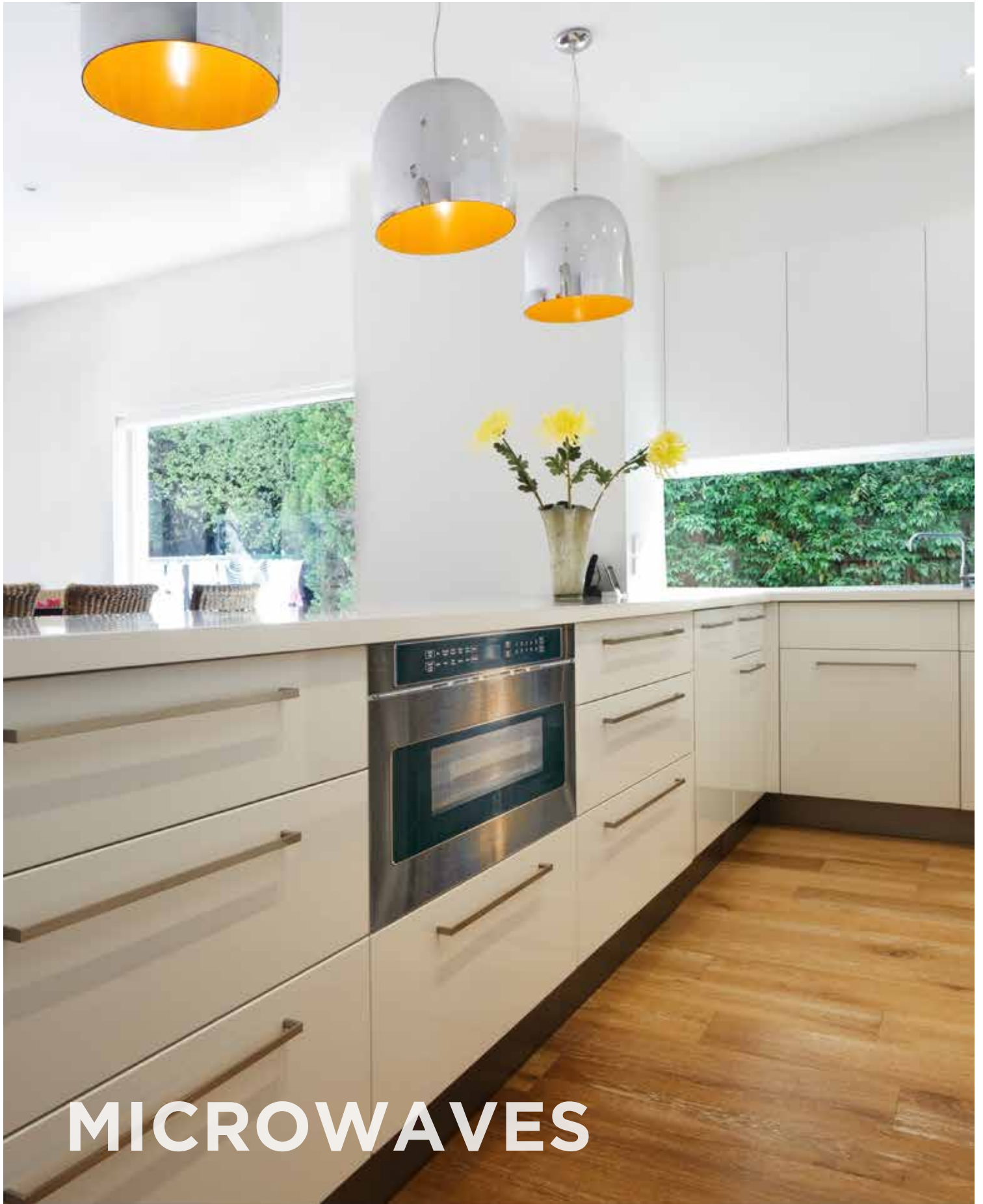

MICROWAVES

COLLECTION MICROWAVE OVENS - **DRAWER UNIT**

Series **700**
Microwave Ovens

F7DMW24S2

24" Microwave Oven Drawer Unit
Series: 700



MICROWAVES



Features

- Stainless Steel Design
- LED Interior Lighting
- Touch Glass Control Panel
- Accessible Height to Easily Remove Hot Food
- Built-In Airflow Control for Flush Installation
- Transparent Glass Door
- 1.2 CuFt Capacity
- 950 Watt Power
- 11 Power Levels
- Flexible Installation

Product Information

MODEL	WIDTH	FINISH	DESCRIPTION	UMRP
F7DMW24S2	24"	Stainless Steel	Microwave Oven Drawer Unit	\$ 1,619

COLLECTION MICROWAVE OVENS - COUNTERTOP / BUILT-IN

MICROWAVES

F4MWO24S1

24" Countertop or Built-In Microwave Oven
Series: 400



Series 400
Microwave Ovens

Features

- Family Size
- 2.0 CuFt Capacity
- 1100 Watt Power
- 11 Power Levels
- Push Button Opener
- Electronic Touch Control
- Super Defrost
- Sensor Cook Menu
- Auto Start
- Child Lock
- 4 Program Stages



Product Information

MODEL	WIDTH	FINISH	DESCRIPTION	UMRP
F4MWO24S1	24"	Stainless Steel	Countertop or Built-In Microwave Oven	\$ 559

Optional Accessories

MODEL	DESCRIPTION	UMRP
F4TK30MWO	30" Stainless Steel Trim Kit for Built-In Installation	\$ 479

COLLECTION MICROWAVE OVENS - **OVER THE RANGE**

Series **400**
Microwave Ovens

F4OTR30S1
30" OTR Microwave Oven
Series: 400



30" Features

- 1.8 CuFt Capacity
- 1100 Watt Power
- 10 Power Levels
- LED Display
- LED Lighting
- Recessed Cavity
- Child-Safe Lock-Out Feature
- Removable Glass Turntable
- 450 CFM
- Ducted or Recirculating Installation
- Charcoal Filter Included



Product Information

MODEL	WIDTH	FINISH	DESCRIPTION	UMRP
F4OTR30S1	30"	Stainless Steel	OTR Microwave Oven	\$ 669



COFFEE SYSTEMS

COLLECTION BUILT-IN PRODUCTS - COFFEE MACHINE

Features

- Whole Bean Coffee Grinder
- 13 Brewing Functions
- Touch Control Panel
- Dual Dispensing for 2 Cups
- Adjustable Coffee Strength and Grinder Settings
- Fast 3 Minute Heating
- Auto Start Function
- Automatic Cleaning Cycle
- Incuded Milk Froth Pitcher
- Removable Water Tank

Function

- 3 Coffee Temperature Settings
- 5 Coffee Strength Settings
- 5 Mug Size Settings
- Steam and Frothing
- Hot Water Dispenser
- Telescopic Easy Clean Access
- Stand-by (Energy Saving) Mode

Safety

- Water hardness setting
- Coffee and water refill indicators
- One Touch Cleaning Cycle
- Limescale Filter
- Empty Coffee Grounds Indicator

F7BC

24" Built-In Coffee Machine 
Series: 700



30" TRIM KITS



F7DTK30BC



F6DTK30BC

Product Information

MODEL	WIDTH	FINISH	DESCRIPTION	UMRP
F7BC24B1	24"	Black Glass	Built-In Coffee Machine	\$ 3,399
F7BC24S1	24"	Stainless Steel	Built-In Coffee Machine	\$ 3,499

Optional Accessories

MODEL	DESCRIPTION	UMRP
F7DTK30BC	30" Trim Kit for Black Unit Only (F7BC24B1)	\$ 699
F6DTK30BC	30" Professional Trim Kit for Black Unit Only (F7BC24B1)	\$ 699

COFFEE

EXPLORE OUR NEW COLUMN REFRIGERATION



Automatic Defrost System

Extra Deep Storage Capacity

Ice Maker with Adjustable Cube Size

Full Extension Bins

Natural wood shelves

Two temperature zones

Available in Stainless Steel
and Panel-Ready options

Zero-Clearance,
Heavy-Duty
Stainless Steel
Hinge System

LED
Lighting

Lateral
Airflow
Curtain

Brilliant White
Aluminum and
Stainless Steel
Interior

Stainless Steel
Soft-Close
Crisper Drawers

Full-Extension Soft
Close Drawers



REFRIGERATION

SOFIA REFRIGERATION - COLUMN REFRIGERATORS

F7SRC / F7IRC

Column Refrigerator
Series: 700

Series 700

Features

- Lateral Airflow Curtain
- Brilliant White Aluminum and Stainless Steel Interior
- Height Adjustable Glass Shelves
- Extra Deep Storage Capacity
- Full Extension Microbeaded Stainless Steel Soft Close Drawers
- Multilevel LED Lighting
- Interior LED Digital Touch Interface
- Super Quiet 41 dB Noise Level
- Available in Stainless Steel and Panel Ready Options
- Stainless Steel Model Ships with Sofia Pro Handle
- Refrigerator Available in Widths: 24", 30" and 36"
- Joining Kit Included with Freezer and Wine Column



Product Information

MODEL	WIDTH	FINISH	DESCRIPTION	UMRP
F7SRC24S1-R	24"	Stainless Steel	Column Refrigerator, RH	\$ 8,999
F7SRC24S1-L	24"	Stainless Steel	Column Refrigerator, LH	\$ 8,999
F7IRC24O1-R	24"	Panel Ready	Column Refrigerator, Panel Ready, RH	\$ 8,799
F7IRC24O1-L	24"	Panel Ready	Column Refrigerator, Panel Ready, LH	\$ 8,799
F7SRC30S1-R	30"	Stainless Steel	Column Refrigerator, RH	\$ 9,299
F7SRC30S1-L	30"	Stainless Steel	Column Refrigerator, LH	\$ 9,299
F7IRC30O1-R	30"	Panel Ready	Column Refrigerator, Panel Ready, RH	\$ 9,099
F7IRC30O1-L	30"	Panel Ready	Column Refrigerator, Panel Ready, LH	\$ 9,099
F7SRC36S1-R	36"	Stainless Steel	Column Refrigerator, RH	\$ 9,599
F7SRC36S1-L	36"	Stainless Steel	Column Refrigerator, LH	\$ 9,599
F7IRC36O1-R	36"	Panel Ready	Column Refrigerator, Panel Ready, RH	\$ 9,399
F7IRC36O1-L	36"	Panel Ready	Column Refrigerator, Panel Ready, LH	\$ 9,399

Optional Accessories

MODEL	FINISH	DESCRIPTION	UMRP
REFJOINKIT	Panel Ready	Universal Joining Kit for Column Refrigeration, White	\$ 279
REFSBSINT60	Panel Ready	Joining Strip Only for Panel Ready Columns, White	\$ 269
REFSBSCLR60	Stainless Steel	Joining Kit for Column Refrigeration, Gray	\$ 259
REFHANDISCOL	Panel Ready	Distinto Column Handle Kit for Panel Ready Units	\$ 309
REFHANDPROCOL	Panel Ready	Sofia Column Handle Kit for Panel Ready Units	\$ 269

SOFIA REFRIGERATION - COLUMN FREEZERS

Series 700

REFRIGERATION



F7SFC / F7IFC

Column Freezer
Series: 700

Features

- Lateral Airflow Curtain
- Brilliant White Aluminum and Stainless Steel Interior
- Extra Deep Storage Capacity
- Total No Frost
- Metal Freezer Bins on Stainless Steel Glides
- Filtered Ice Maker with Adjustable Cube Sizes
- Multilevel LED Lighting
- Interior LED Digital Touch Interface
- Super Quiet 41 dB Noise Level
- Available in Stainless Steel and Panel Ready Options
- Joining Kit is Included (White)
- Freezer Available in Widths: 18", 24", 30" and 36"

Product Information

MODEL	WIDTH	FINISH	DESCRIPTION	UMRP
F7SFC18S1-L	18"	Stainless Steel	Column Freezer, LH	\$ 8,599
F7SFC18S1-R	18"	Stainless Steel	Column Freezer, RH	\$ 8,599
F7IFC18O1-L	18"	Panel Ready	Column Freezer, Panel Ready, LH	\$ 8,399
F7IFC18O1-R	18"	Panel Ready	Column Freezer, Panel Ready, RH	\$ 8,399
F7SFC24S1-L	24"	Stainless Steel	Column Freezer, LH	\$ 8,699
F7SFC24S1-R	24"	Stainless Steel	Column Freezer, RH	\$ 8,699
F7IFC24O1-L	24"	Panel Ready	Column Freezer, Panel Ready, LH	\$ 8,499
F7IFC24O1-R	24"	Panel Ready	Column Freezer, Panel Ready, RH	\$ 8,499
F7SFC30S1-L	30"	Stainless Steel	Column Freezer, LH	\$ 9,099
F7SFC30S1-R	30"	Stainless Steel	Column Freezer, RH	\$ 9,099
F7IFC30O1-L	30"	Panel Ready	Column Freezer, Panel Ready, LH	\$ 8,999
F7IFC30O1-R	30"	Panel Ready	Column Freezer, Panel Ready, RH	\$ 8,999
F7SFC36S1-L	36"	Stainless Steel	Column Freezer, LH	\$ 9,699
F7SFC36S1-R	36"	Stainless Steel	Column Freezer, RH	\$ 9,699
F7IFC36O1-L	36"	Panel Ready	Column Freezer, Panel Ready, LH	\$ 9,499
F7IFC36O1-R	36"	Panel Ready	Column Freezer, Panel Ready, RH	\$ 9,499

Optional Accessories

MODEL	FINISH	DESCRIPTION	UMRP
REFSBSINT60	Panel Ready	Joining Strip Only for Panel Ready Columns, White	\$ 269
REFSBCGR60	Stainless Steel	Joining Kit for Column Refrigeration, Gray	\$ 259
REFHANDISCOL	Panel Ready	Distinto Column Handle Kit for Panel Ready Units	\$ 309
REFHANDPROCOL	Panel Ready	Sofia Column Handle Kit for Panel Ready Units	\$ 269

SOFIA REFRIGERATION - COLUMN WINE RESERVES

Series 700

REFRIGERATION

F7SWC24S1 / F7IWC24O1

Column Wine Reserve
Series: 700

Features

- Lateral Airflow Curtain
- Two Independent Temperature Zones
- Brilliant White Aluminum and Stainless Steel Interior
- Extra Deep Storage Capacity
- 12 Natural Wood Shelves for 80 Bottles Total Storage Capacity
- Multilevel LED lighting
- Interior LED Digital Touch Interface
- Super Quiet 41 dB Noise Level
- Available in Stainless Steel and Panel Ready Options
- Joining Kit is Included (White)
- Wine Reserve Available in 24" Width
- Upper Wine Compartment - 50°F - 64°F
- Lower Wine Compartment - 39°F - 55°F



Product Information

MODEL	WIDTH	FINISH	DESCRIPTION	UMRP
F7SWC24S1-R	24"	Stainless Steel	Column Wine Reserve, Dual Zone, RH	\$ 11,499
F7SWC24S1-L	24"	Stainless Steel	Column Wine Reserve, Dual Zone, LH	\$ 11,499
F7IWC24O1-R	24"	Panel Ready	Column Wine Reserve, Dual Zone, Panel Ready, RH	\$ 10,899
F7IWC24O1-L	24"	Panel Ready	Column Wine Reserve, Dual Zone, Panel Ready, LH	\$ 10,899

Optional Accessories

MODEL	FINISH	DESCRIPTION	UMRP
REFSBSINT60	Panel Ready	Joining Strip Only for Panel Ready Columns, White	\$ 269
REFSBSICGR60	Stainless Steel	Joining Kit for Column Refrigeration, Gray	\$ 259
REFHANDISCOL	Panel Ready	Distinto Column Handle Kit for Panel Ready Units	\$ 309
REFHANDPROCOL	Panel Ready	Sofia Column Handle Kit for Panel Ready Units	\$ 269

SOFIA REFRIGERATION - BUILT-IN REFRIGERATOR

Series 700

REFRIGERATION



Stainless Model

See previous page for interior details

Panel Ready Model

F7PBM36S1 / F7IBM3601

36" Professional Refrigerator

Series: 700

Features

- Flexzone Bottom Drawer that can be converted to refrigerator, freezer or fresco
- Lateral Airflow Curtain
- Brilliant White Aluminum and Stainless Steel Interior
- Extra Deep Storage Capacity
- Automatic Defrost System
- Full Extension Stainless Steel Soft Close Drawers
- Filtered Ice Maker with Adjustable Cube Sizes
- LED Lighting
- Interior LED Digital Touch Interface
- Super Quiet 41 dB Noise Level
- Available in Stainless Steel and Panel Ready Options

Product Information

MODEL	WIDTH	FINISH	DESCRIPTION	UMRP
F7PBM36S1-L	36"	Stainless Steel	Professional Refrigerator, Left Hinge	\$ 11,499
F7PBM36S1-R	36"	Stainless Steel	Professional Refrigerator, Right Hinge	\$ 11,499
F7IBM3602-L	36"	Panel Ready	Refrigerator, Left Hinge	\$ 10,699
F7IBM3602-R	36"	Panel Ready	Refrigerator, Right Hinge	\$ 10,699

Optional Accessories

MODEL	DESCRIPTION	UMRP
REFSBSPRO60	Sofia 1-Piece Joining Kit (Incl. Joining Strip, 60" 1-Piece Upper Grill, Toe Kick and Insulated Blanket)	\$ 1,439
REFSBSPRO72	Sofia 1-Piece Joining Kit (Incl. Joining Strip, 72" 1-Piece Upper Grill, Toe Kick and Insulated Blanket)	\$ 1,549
REFSBSENT60	Joining Strip Only for Integrated Units	\$ 269
REFHANDPRO36	Sofia 36" Refrigerator PRO Handle for Panel Ready or Stainless Steel Model	\$ 479
REFHANDIS36	Distinto 36" Refrigerator Handle for Panel Ready Model	\$ 479
1R0000843	Refrigerator Filter Replacement (F7PBM36S1 & F7IBM3601)	\$ 180

SOFIA REFRIGERATION - BUILT-IN WINE RESERVES

Series 700

REFRIGERATION

F7PBW24S1 / F7IBW24O1

24" Wine Reserve

Series: 700

Features

- 3 Independent Temperature Zones
- Flexzone Bottom Drawer that can be converted to refrigerator, freezer or fresco
- Upper Wine Compartment - 50°F - 64°F
- Lower Wine Compartment - 39°F - 55°F
- Cellar Storage Top Compartment with Natural Wood Shelves for 36 Bottles
- Wine Cellar Bottom Compartment with Natural Wood Shelves for 18 Bottles
- Lateral Airflow Curtain
- Automatic Defrost System
- LED Lighting
- Brilliant White Aluminum Interior
- Extra Deep Storage Capacity
- Available in Stainless Steel and Panel Ready Options



Stainless Version

Panel Ready Version

Product Information

MODEL	WIDTH	FINISH	DESCRIPTION	UMRP
F7PBW24S1-L	24"	Stainless Steel	Professional Wine Reserve, Left Hinge	\$ 12,699
F7PBW24S1-R	24"	Stainless Steel	Professional Wine Reserve, Right Hinge	\$ 12,699
F7IBW24O1-L	24"	Panel Ready	Wine Reserve, Left Hinge	\$ 11,799
F7IBW24O1-R	24"	Panel Ready	Wine Reserve, Right Hinge	\$ 11,799

Optional Accessories

MODEL	DESCRIPTION	UMRP
REFHANDPRO24	Sofia 24" Refrigerator PRO Handle Kit for Panel Ready or Stainless Steel Models	\$ 409
REFHANDIS24	Distinto 24" Refrigerator Handle Kit for Panel Ready Model	\$ 409

Series 400 Refrigerator

FM4BM30

30" and 36" Built-In Refrigerator
36" Built-In French Door Refrigerator
Series: 400

Features

- Contemporary European Design
- Hettich™ Hinge System
- Digital Display
- Soft Close Crisper
- Soft Close Pantry Drawer
- Temperature Alarm
- Fast Cooling/Freezing Feature
- Glass Shelves
- LED Lighting
- Field Reversible Doors
- Ultra-Quiet Operation - 43 dB
- Height Adjustable Cantilever Shelves
- Optional Interior Filtered Water Dispenser and Automatic Ice Maker IF Built-In
- Sabbath Mode
- 84 1/2" Tall for Built-In Installation



NEW



FM4BM30IFBI

Product Information

MODEL	WIDTH	FINISH	DESCRIPTION	UMRP
FM4BM30IFBI	30"	Panel Ready (w/Ice & Water)	Built-In Refrigerator	\$ 4,199
FM4BM30FBI	30"	Panel Ready	Built-In Refrigerator	\$ 4,999

Optional Accessories

MODEL	DESCRIPTION	UMRP
F4HKPRO30BM	Sofia Pro Handle Kit for 30" Built-In Refrigerators	\$ 369
F4HKDIST30BM	Distinto Handle Kit for 30" Built-In Refrigerators	\$ 239
FMPANEL30BMSS	Stainless Panel for 30" Refrigerator	\$ 1,479
FM4JOINKIT	Joining Kit for 400 Series Built-In Refrigerators	\$ 339

Series 400
Refrigerator

FM4BM36

36" Built-In Refrigerator
Series: 400

Features

- Contemporary European Design
- Hettich™ Hinge System
- Digital Display
- Soft Close Crisper
- Soft Close Pantry Drawer
- Temperature Alarm
- Fast Cooling/Freezing Feature
- Glass Shelves
- LED Lighting
- Field Reversible Doors
- Ultra-Quiet Operation - 43 dB
- Height Adjustable Cantilever Shelves
- Optional Interior Filtered Water Dispenser and Automatic Ice Maker IF Built-In
- Sabbath Mode
- 84 1/2" Tall for Built-In Installation

NEW



FM4BM36FBI

Product Information

MODEL	WIDTH	FINISH	DESCRIPTION	UMRP
FM4BM36FBI	36"	Overlay (w/Ice & Water)	Built-In Refrigerator	\$ 6,299
FM4BM36IFBI	36"	Overlay	Built-In Refrigerator	\$ 7,199

Optional Accessories

MODEL	DESCRIPTION	UMRP
F4HKPRO36BM	Sofia Pro Handle Kit for 30" Built-In Refrigerators	\$ 369
F4HKDIST36BM	Distinto Handle Kit for 30" Built-In Refrigerators	\$ 239
FMPANEL36BMSS	Stainless Panel for 30" Refrigerator	\$ 1,479
FM4JOINKIT	Joining Kit for 400 Series Built-In Refrigerators	\$ 339

Series 400
Refrigerator

FM4FBM36

36" Built-In French Door Refrigerator
Series: 400

Features

- Contemporary European Design
- Hettich™ Hinge System
- Digital Display
- Soft Close Crisper
- Soft Close Pantry Drawer
- Temperature Alarm
- Fast Cooling/Freezing Feature
- Glass Shelves
- LED Lighting
- Field Reversible Doors
- Ultra-Quiet Operation - 43 dB
- Height Adjustable Cantilever Shelves
- Optional Interior Filtered Water Dispenser and Automatic Ice Maker IF Built-In
- Sabbath Mode
- 84 1/2" Tall for Built-in



FM4FBM36FBI

Product Information

MODEL	WIDTH	FINISH	DESCRIPTION	UMRP
FM4FBM36FBI	36"	Overlay (w/Ice & Water)	Built-In French Door Refrigerator	\$ 7,299
FM4FBM36IFBI	36"	Overlay	Built-In French Door Refrigerator	\$ 8,199

Optional Accessories

MODEL	DESCRIPTION	UMRP
F4HKPRO36BM	Sofia Pro Handle Kit for 30" Built-In Refrigerators	\$ 369
F4HKDIST36BM	Distinto Handle Kit for 30" Built-In Refrigerators	\$ 239
FMPANEL36BMSS	Stainless Panel for 30" Refrigerator	\$ 1,479
FM4JOINKIT	Joining Kit for 400 Series Built-In Refrigerators	\$ 339

SOFIA REFRIGERATION - FREESTANDING REFRIGERATOR

REFRIGERATION

F6FBM36S2

36" Professional Counter Depth Refrigerator
Series: 600

Features

- Duo Cycle Cooling
- Height Adjustable Glass Cantilever Shelves
- Blue Lights to Increase Produce Life
- Ion Fresh System
- Interactive Digital Display
- Sabbath Mode
- Automatic Ice Machine
- Interior Filtered Water Dispenser
- Large Bottom Freezer Drawer
- Large Pantry Drawer in Freezer
- Theater LED Lighting

SOFIA
Professional 600
Freestanding Refrigerator



Product Information

MODEL	WIDTH	FINISH	DESCRIPTION	UMRP
F6FBM36S2	36"	Stainless Steel	Freestanding Refrigerator	\$ 3,849
F6HK36FFBS	36"	Stainless Steel	Sofia Pro Handle and Badge Kit for Freestanding Refrigerator	\$ 349
F7HK36FFBS	36"	Stainless Steel	Distinto Handle Kit for Freestanding Refrigerator	\$ 249

Optional Accessories

MODEL	DESCRIPTION	UMRP
1R0000938	Refrigerator Filter Replacement (F6FBM36S2)	\$ 86.50

*** MUST ORDER HANDLE KIT ***

FM4FBM36SS

36" Professional Counter Depth Refrigerator
Series:400

Features

- 20.3 cubic feet in size
- Includes a Sofia Pro handle
- Electronic control on top of the cabinet
- Fridge compartment has a stainless-steel back panel
- Three crisper drawers with humidity adjustment on vegetable crispers
- Six-door bins in refrigeration, including two-gallon bins
- LED lighting
- Automatic ice maker (up to five pounds per day)
- Frost free
- One inner drawer inside the freezer drawer
- External water filter recommended
- One-year parts and labor warranty

SOFIA

Professional 400
REFRIGERATION

NEW



Product Information

MODEL	WIDTH	FINISH	DESCRIPTION	UMRP
FM4FBM36SS	36"	Stainless Steel	Freestanding Refrigerator	\$ 3,499

Optional Accessories

MODEL	DESCRIPTION	UMRP
FH000740801	Refrigerator Filter Replacement (FM4FBM36SS)	\$ 86.50
F7HK36FFBS	Distinto Handle Kit for Freestanding Refrigerator	\$ 269



DISHWASHERS

SOFIA DISHWASHERS

DISHWASHERS

SOFIA Professional 600 Dishwasher

F6DWT24
24" Dishwashers
Series: 600



Features

- Quiet Plus - 45 dB
- Stainless Steel Interior Tub
- 6 Wash Cycles
- Fast Function Wash Cycle
- Flexible Rack Loading
- 3rd Rack for Extra Capacity
- Filtering System
- Half Load Cycle
- 16 Place Settings
- Adjustable Feet
- Concealed Heating Element
- Adjustable Hinge System
- Extreme Wash (Sanitization)
- Must Order Handle Kit with Stainless Steel Model
- Optional Logo Badge

Product Information

MODEL	WIDTH	FINISH	DESCRIPTION	UMRP
F6DWT24SS2 *	24"	Stainless Steel	Dishwasher	\$ 1,149
F6UHK24DISH	24"	Sofia	Sofia Handle and Badge Kit	\$ 159

* Discontinued once inventory levels are depleted

ADA DISHWASHERS

DISHWASHERS

Series 700
Dishwashers

F7DWS24FI1

18" & 24" ADA Dishwashers
Series: 700



Features

- ADA Compliant
- Quiet Plus - 49 dB
- Stainless Steel Interior Tub
- 6 Wash Cycles
- Flexible Rack Loading
- 6 Place Settings
- Super Active Drying
- Fully Built-In
- Top Control
- Adjustable Feet
- Concealed Heating Element
- Adjustable Hinge System
- 2 Foldable Racks
- Upper Basket
- Advanced Filtering system

Product Information

MODEL	WIDTH	FINISH	DESCRIPTION	UMRP
F7DWS24FI1	24"	Panel Ready	Dishwasher	\$ 1,099

SOFIA DISHWASHERS - AVAILABLE SUMMER 2024

DISHWASHERS

Series 700
Dishwasher

F7DWT
24" Dishwashers
Series: 700



Features

- Quiet Plus - 45 dB
- Stainless Steel Interior Tub
- 6 Wash Cycles
- Fast Function Wash Cycle
- Flexible Rack Loading
- 3rd Rack for Extra Capacity
- 16 Place Settings
- Filtering System
- Half Load Cycle
- Adjustable Feet
- Concealed Heating Element
- Adjustable Hinge System
- Extreme Wash (Sanitization)
- Must Order Handle Kit with Stainless Steel Model

Product Information

MODEL	WIDTH	FINISH	DESCRIPTION	UMRP
F7DWT24SS1	24"	Stainless Steel	700 Series Dishwasher	\$ 1,199
F7DWT24FI1	24"	Panel Ready	700 Series Dishwasher	\$ 1,099
F6UHK24DISH	24"	Sofia	Sofia Handle and Badge Kit	\$ 159
F7HK24DISHS	24"	Distinto	Handle Kit*	\$ 89

DISHWASHERS

Series 400
Dishwashers

F4DWT

24" Dishwashers
Series: 400



Features

- Quiet Plus - 49 dB
- Stainless Steel Interior Tub
- 6 Wash Cycles
- Flexible Rack Loading
- 14 Place Settings
- Super Active Drying
- Fully Built-In
- Top Control
- Adjustable Feet
- Concealed Heating Element
- Adjustable Hinge System
- 2 Foldable Racks
- Upper Basket
- Advanced Filtering system

Product Information

MODEL	WIDTH	FINISH	DESCRIPTION	UMRP
F4DWT24SS1	24"	Stainless Steel	400 Series Dishwasher	\$ 899
F4DWT24FI1 *	24"	Panel Ready	400 Series Dishwasher	\$ 829
F6UHK24DISH	24"	Sofia	Sofia Handle and Badge Kit	\$ 159
F7HK24DISHS	24"	Distinto	Handle Kit*	\$ 89

ADA DISHWASHERS

DISHWASHERS

Series 400 Dishwashers

F4DWS

18" & 24" ADA Dishwashers
Series: 400



Features

- ADA Compliant
- Quiet Plus - 49 dB
- Stainless Steel Interior Tub
- 6 Wash Cycles
- Flexible Rack Loading
- 14 Place Settings
- Super Active Drying
- Fully Built-In
- Top Control
- Adjustable Feet
- Concealed Heating Element
- Adjustable Hinge System
- 2 Foldable Racks
- Upper Basket
- Advanced Filtering system

Product Information

MODEL	WIDTH	FINISH	DESCRIPTION	UMRP
F4DWS24FI1	24"	Panel Ready	400 Series ADA Dishwasher	\$ 829
F4DWS18FI1	18"	Panel Ready	400 Series ADA Dishwasher	\$ 849



VENTILATION

LINER INSERTS

Series ⁴⁰⁰ & ⁶⁰⁰
Inserts

F4BP28S1/ F6BP34DS1 / F6BP46DS1

28", 34", 46" Baffle Filter Professional Insert
Series: 400 & 600



F6BP34S1



F6BP34DS1

Features

- Scotch Bright Stainless Steel
- Heavy Duty Control Panel with Knobs
- LED Lighting
- Slider Control on 28" Model Only
- 600 CFM or 1000 CFM
- Dual Fan Motors on 1,000 CFM Models
- Professional Baffle Filters

Product Information

MODEL	WIDTH	FINISH	CFM	DESCRIPTION	UMRP
F4BP28S1	28"	Stainless Steel	600	Insert Baffle Filter	\$ 899
F6BP34S1	34"	Stainless Steel	600	Insert Baffle Filter	\$ 1,299
F6BP34DS1	34"	Stainless Steel	1000	Sofia Insert Baffle Filter	\$ 1,379
F6BP46DS1	46"	Stainless Steel	1000	Sofia Insert Baffle Filter	\$ 1,549

Optional Accessories

MODEL	DESCRIPTION	UMRP
FMFIL	Round Carbon Recirculating Filter	\$ 69

SOFIA HOODS

SOFIA
Professional Hoods 600

F6PC36/F6PC48 Hood

36" , 48" Professional Chimney Hood
Series: 600

VENTILATION



Features

- Scotch Brite Stainless Steel
- Heavy Duty Control Panel with Knobs
- 3 Speed Settings
- LED Lighting
- Dual Fan Motors
- Professional Baffle Filters
- 1,000 CFM
- Optional Logo Badge
- Adjustable Duct Extension for up to 9' Ceiling

Product Information

MODEL	WIDTH	FINISH	CFM	DESCRIPTION	UMRP
F6PC36DS1	36"	Stainless Steel	1000	Sofia Hood Baffle Filter	\$ 2,179
F6PC48DS1	48"	Stainless Steel	1000	Sofia Hood Baffle Filter	\$ 2,459

Optional Accessories

MODEL	DESCRIPTION	UMRP
FMFIL	Round Carbon Recirculating Filter	\$ 69
KCPHN.00#3	Adjustable Chimney Extension (Max 60" / For 36" and 48" hoods)	\$ 279

SOFIA HOODS

SOFIA Professional Hoods 600

F6PH Hood

30", 36", and 48" Professional Hood
Series: 600



F6PH30S1 / F6PH36S1

- Scotch Bright Stainless Steel
- Slider Controls
- 4 Speed Control
- LED Lighting
- Single Fan Motor
- Professional Baffle Filters

F6PH30S2 / F6PH36DS1 / F6PH48DS1

- Scotch Bright Stainless Steel
- Heavy Duty Control Panel with Knobs
- 4 Speed Control
- LED Lighting
- Dual Fan Motors (1000 CFM Models)
- Professional Baffle Filters

Product Information

MODEL	WIDTH	FINISH	CFM	DESCRIPTION	UMRP
F6PH30S1	30"	Stainless Steel	600	Sofia Hood, Slide Controls	\$ 1,299
F6PH30S2	30"	Stainless Steel	600	Sofia Hood, Knob Controls	\$ 1,399
F6PH36S1	36"	Stainless Steel	600	Sofia Hood, Slide Controls	\$ 1,699
F6PH36DS1	36"	Stainless Steel	1000	Sofia Hood, Knob Controls	\$ 2,099
F6PH48DS1	48"	Stainless Steel	1000	Sofia Hood, Knob Controls	\$ 2,349

Optional Accessories

MODEL	DESCRIPTION	UMRP
F6CK30-12	30" Chimney Extension Cover, 12" Tall	\$ 269
FMFIL	Round Carbon Recirculating Filter	\$ 69

COLLECTION HOODS - **UNDER CABINET HOOD**

Series **400**
Hoods

F4UC30S1 & F4UC36S1
30" & 36" Under Cabinet Hood
Series: 400

VENTILATION



F4UC30S1



F4UC36S1

Features

- Scotch Bright Stainless Steel
- 450 CFM
- Electronic Controls
- LED Lighting
- Hybrid Baffle Filters

Product Information

MODEL	WIDTH	FINISH	DESCRIPTION	UMRP
F4UC30S1	30"	Stainless Steel	Under Cabinet Hood	\$ 1,079
F4UC36S1	36"	Stainless Steel	Under Cabinet Hood	\$ 1,179

Optional Accessories

MODEL	DESCRIPTION	UMRP
FMFIL	Round Carbon Recirculating Filter	\$ 59

Series 400
Hoods

F4CW30 & F4CW36

30" & 36" Wall Mount Chimney Hood
Series: 400



Features

- Scotch Brite 304 Stainless Steel
- Electronic Controls
- 4 Speed Settings
- LED Lighting
- Hybrid Baffle Filters
- 600 CFM
- Optional Recirculating Kit
- Adjustable Duct Extension for up to 9' Ceilings

Product Information

MODEL	WIDTH	FINISH	CFM	DESCRIPTION	UMRP
F4CW30S1	30"	Stainless Steel	600	Baffle Filter Hood	\$ 1,279
F4CW36S1	36"	Stainless Steel	600	Baffle Filter Hood	\$ 1,349

Optional Accessories

MODEL	DESCRIPTION	UMRP
FMFILCW	Square Charcoal Filter	\$ 39
KACL.512#I	Duct Extension - 38" (for 12' Ceiling)	\$ 219
KACL.510#I	Duct Extension - 27" (for 11' Ceiling)	\$ 209

LINE DRAWING MAP FOR PROFESSIONAL BUILT-IN OVENS SINGLE AND DOUBLE

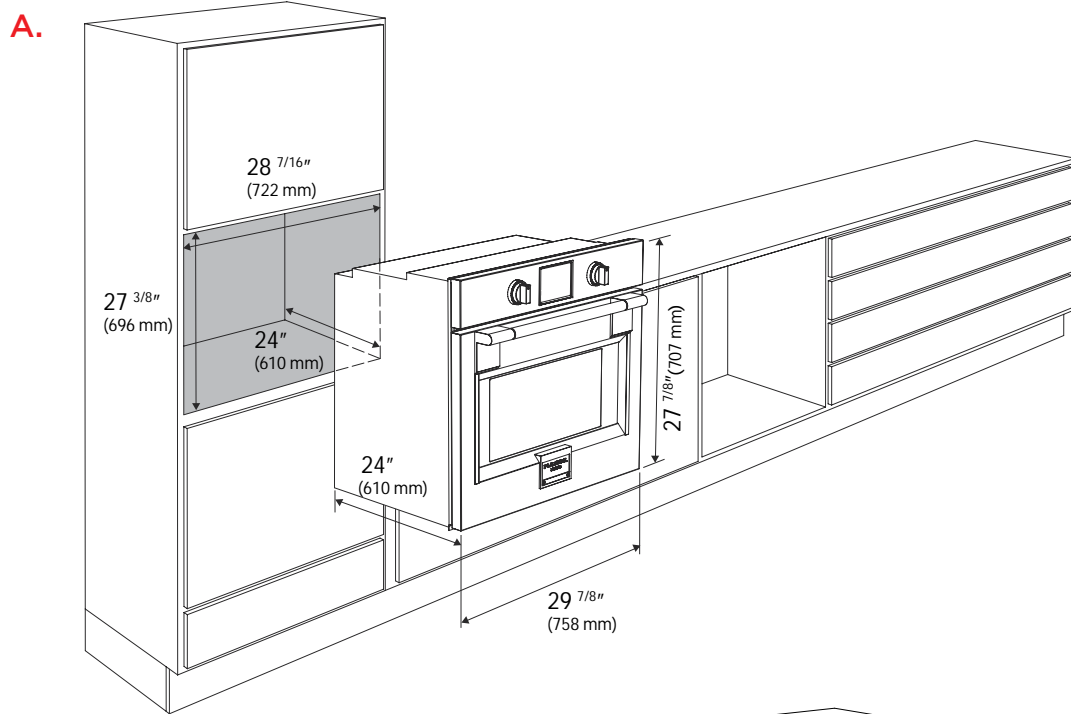

B.

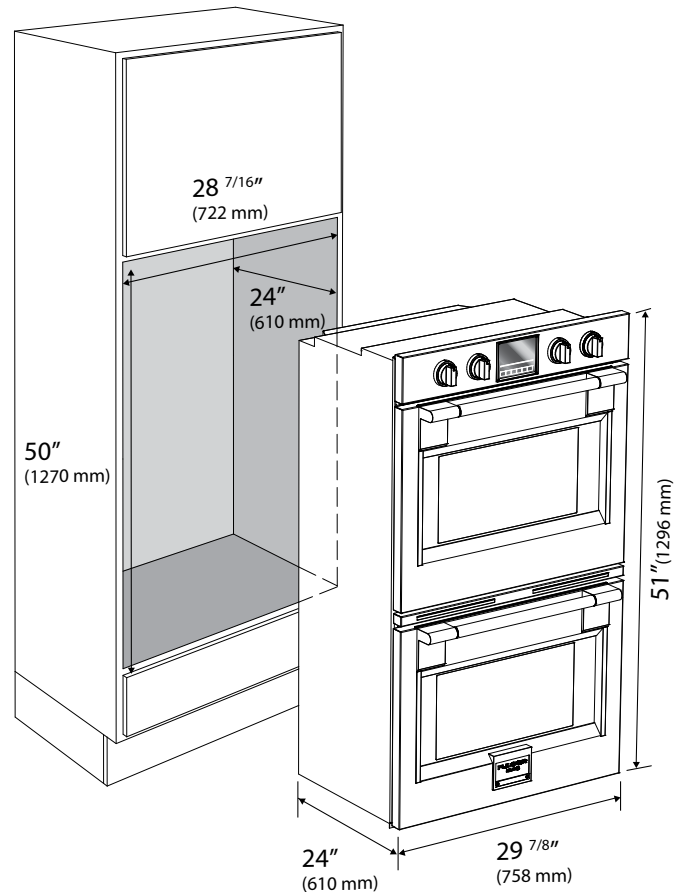

A. F6PSP30S1 (p.17)
30" Professional Single Oven
Series: 600

B. F6PDP30S1 (p.18)
30" Professional Double Oven
Series: 600

Warranty Class	Description of Warranty Coverage
0	Doors, handles, glass, product frames, racking, interior and exterior surfaces are covered by a limited 30-day parts-only warranty for cosmetic defects proven to have originated from the factory. It is the responsibility of the owner to inspect the product and report any such claims within this 30 day period.
1	1 year parts and labor
2	2 years parts and labor
5	5 years parts and labor on the following sealed system components only: compressor, condenser, evaporator, dryer and connective tubing
5p	5 years parts only on the following sealed system components only: compressor, condenser, evaporator, dryer and connective tubing
12p	12 years parts only on the following sealed system components only: compressor, condenser, evaporator, dryer and connective tubing

Product Class	Applicable Warranties	For proof of warranty, please retain the original purchase invoice and the delivery slip. To obtain service under these warranties you must:
Cooking		
Drop-in Cooktops	0,2	1. Contact Maple Distributing Authorized Service <ul style="list-style-type: none"> a. By email at support@mapledistributing.com a. Log all your information on www.mapledistributing.com under Service Request for immediate assistance. b. Toll free at 800-866-4774. 2. Provide a copy of your original sales receipt along with model number and serial number information for the product. 3. Provide Fulgor Milano reasonable opportunity to investigate the claim before the product or any component of the product has been modified or removed.
Built-in Ovens	0,2	
Rangetops	0,2	
Microwaves	0,1	
Freestanding Ranges	0,2	
Cleaning		
Dishwashers	0,2	
Cooling		
Built-in (700 series) Refrigeration and Wine	0,2,5,12p	
All Other Refrigeration	0,2,5p	
Ventilation		
Ventilation Hoods	0,2	

TERMS APPLICABLE TO THESE WARRANTIES

All applicable warranties for each class run concurrently. In accordance to the applicable warranty class, Fulgor Milano warranty covers all parts and / or labor to repair or replace, under normal residential use, any part of the product proving to be defective in material or workmanship as a result of the original manufacturing process. These warranties is valid only in the contiguous states of the U.S.A. including the District of Columbia and Alaska and the country of Canada. These warranties apply to the original purchaser only and are non-transferable. All service provided by Fulgor Milano under the applicable warranty must be performed by a Fulgor Milano authorized servicer unless otherwise specified in writing by Fulgor Milano. Service will be provided during the regular business hours of each specific region. These warranties apply only to products purchased from an authorized dealer through an approved distribution chain and which are installed for normal residential use and do not apply to commercial use or use on yachts. These warranties only cover service performed at the location of product installation and will not cover costs associated with repairing off-site unless expressly authorized by Fulgor Milano nor does it cover the travel costs associated with providing service to remote locations. Remote locations are defined as being outside of a 50 mile (80 kilometre) radius from any authorized 'brick and mortar' dealer. These warranties do not cover any parts or labor needed to correct any defect caused by negligence, transport, delivery, improper voltage or accident or improper use, maintenance, installation, service or repair, including but not limited to improper removal and reinstallation of any component of the product (ie. removing handles to fit through doors) prior to or during product delivery / installation. The remedies described herein are the only ones which Fulgor Milano will provide, either under these warranties or under any warranty arising by operation of law. Fulgor Milano will not be responsible for content loss due to spoilage, freezing or burning nor for consequential damages to surrounding cabinetry, construction materials or finishing materials such as but not limited to flooring. Fulgor Milano will not be responsible for any consequential or incidental damages arising from the breach of these warranties or any other warranties, whether express, implied or statutory. The warranty will be valid and effective only upon presentation of the document stating the purchase date of the appliance, and more specifically of the relevant invoice, proof of purchase or equivalent document showing the name of the seller, the delivery date and the identification data of the appliance (such as; model number and serial number). In the case of new product being included in the purchase of new residential construction; these warranties apply to the original resident of the location containing the Fulgor Milano product and warranty coverage will begin on the date of occupancy of the residence (proof of occupancy required) to a maximum additional six months from the date of delivery of the product by the development company from the distributor or dealer. This extension does not apply to the Class 0 cosmetic warranty. These warranties are only valid where the difference between the purchase date and the production date of the product is less than eighteen months. Any product which has been warehoused for more than this period will only be covered by Fulgor Milano's B-Stock warranty. During the warranty period Fulgor Milano reserves the right to evaluate the opportunity to repair the appliance or, at their discretion, offer to replace it with a Fulgor Milano product of equivalent features and functionality but cannot guarantee that the exact model will still be available. Fulgor Milano reserves the right to revise these warranties at any time. Some states do not allow the exclusion or limitation of incidental or consequential damages so the above limitation or exclusion may not apply to you. These warranties give you specific legal rights and you may also have other rights which vary from state to state.

*Replacement light bulbs / LEDs are only covered under the terms of the Class 0, 30 day cosmetic warranty.

Orders: All orders and any subsequent change orders must be submitted in writing and delivered to Maple Distributing, LLC by mail, fax, website, EDI or email. No telephone orders will be accepted. Special Order items are Non-Cancellable.

Prices: All prices are subject to change without notice and are exclusive of any sales or use taxes, shipping, delivery, special packaging, or handling charges that may apply to each customer or to each order.

Minimum Advertised Pricing: All sales are subject to Maple Distributing, LLC or Manufacturer minimum advertised prices. Failure to comply with minimum advertised prices will result in cancellation of any agreement and violators will not be entitled to purchase further products.

Minimum Sale Price: All sales are subject to Maple Distributing, LLC or Manufacturer minimum sale prices. Failure to comply with minimum sale prices will result in cancellation of any agreement and violators will not be entitled to purchase further products.

Freight and Handling: Maple Distributing, LLC dba Maple Distributing, LLC reserves the right to ship products by its choice of carrier. All shipments are F.O.B. from place of shipment, and risk of loss shall pass to the Buyer upon delivery to the carrier at the point of shipment. Additional charges may apply for special handling and packaging.

Deliveries: Maple Distributing, LLC shall not be liable for failure to deliver or for delays in delivery or performance due to: (1) causes beyond its reasonable control; (2) acts of God, acts of Buyer, acts of civil or military authority, governmental allocations or controls, fires, strikes or other labor difficulties, riots or other civil disturbances, delays in its usual source of supply, delays in transportation; (3) any other commercial impracticability. In the event of such delay, the date of delivery or performance shall be extended for a period equal to the time lost by reason of the delay.

Claims: All claims for non-conforming delivery of Products must be made within thirty (30) days of receipt of shipment.

Damage or Loss: Any claim for damage or loss in shipment should be made to the carrier immediately by the customer. Products become the responsibility of the Buyer when accepted by the carrier in good condition from Maple Distributing, LLC and we are not able to process shipping damage claims.

Returns: Only Items marked in this Price List as "Stock Item" are subject to return. All other items are considered Special Order Items and are NOT RETURNABLE. No Products may be returned without a Maple Distributing, LLC Return Goods Authorization (RGA) Number issued prior to the return of Product. Any product returned without an RGA will be refused and returned to the sender. RGA's are valid for thirty (30) days only. All returns are subject to inspection before being approved for credit – products must be in salable condition to be considered for return or replacement. A 20% restocking charge will apply to all returns.

Payment: Unless otherwise noted, payment terms are Net Due on Receipt. Balances owed on invoices over 30 days old are subject to a 1.5% per month charge. Payments made by credit card are subject to a 2% processing fee. Each shipment or delivery shall be deemed to have been sold under a separate and or independent contract and payment thereof shall be made in accordance with the terms of this agreement and of the invoice rendered by Maple Distributing, LLC. Buyer agrees that title to the personal property described herein shall not vest in Buyer until paid in full. In the event of insolvency or the filing of bankruptcy by the Buyer, Buyer agrees to return all merchandise to Maple Distributing, LLC.

Warranties: Products distributed by Maple Distributing, LLC are the products of reputable manufacturers sold under their respective brand or trade names. Maple Distributing, LLC shall use its best efforts to obtain from each manufacturer, in accordance with the manufacturer's warranty or customary practice, the repair or replacement of products that may prove defective in material or workmanship. The foregoing shall constitute the exclusive remedy of the Buyer and the sole obligation of Maple Distributing, LLC. Except as to Title, THERE ARE NO WARRANTIES, EITHER WRITTEN, ORAL, IMPLIED, OR STATUTORY relating to the described products which shall extend beyond that described in this paragraph. NO WARRANTY OF MERCHANTABILITY OR OF FITNESS FOR PURPOSE SHALL APPLY.

Limitation of Liability: Maple Distributing, LLC's liability on any claims for loss or damage arising out of this contract or from the performance or breach thereof or connected with the supplying of products hereunder, or its sale, resale, operation or use, whether based on warranty, contract, negligence or other grounds shall not exceed the price allowable for such products or parts thereof involved in the claim. Maple Distributing, LLC shall not, under any circumstances, be liable for any labor charges unless agreed upon in advance and in writing by Maple Distributing, LLC and the manufacturer of the products involved. Maple Distributing, LLC shall not in any event be liable for special or consequential damages, including, but not limited to, loss of profits or revenue, loss of use of the product or any associated product, cost of capital, cost of substitute products, facilities or services, downtime costs, or claims of customers of the Buyer for such damages.

General: The possession of this Price List by anyone is not to be considered as an offer to sell any of the Products contained herein. This Price List supercedes all previous price lists or memorandums. Maple Distributing, LLC's existing Trade Terms and Conditions remain in effect. The above Terms and Conditions shall be a part of all Orders accepted by Maple Distributing, LLC and shall supercede any conflicting provisions of our customer's purchase orders. These terms and conditions are subject to change without notice.



Maple Distributing

2100 Century Cir. • Irving, TX 75062 Phone: 800-292-8374
www.mapledistributing.com